

Instruções de uso

ADVINCULA DELINEATOR

CooperSurgical

Instructions for Use (English)

Notice d'utilisation (Français)

Instrucciones de uso (Español)

Istruzioni per l'uso (Italiano)

Gebrauchsanweisung (Deutsch)

Instruções de utilização (Português)

Gebruiksaanwijzingen (Nederlands)

Kullanım Talimatları (Türkçe)

사용법 설명서 (한국어)

CE0086

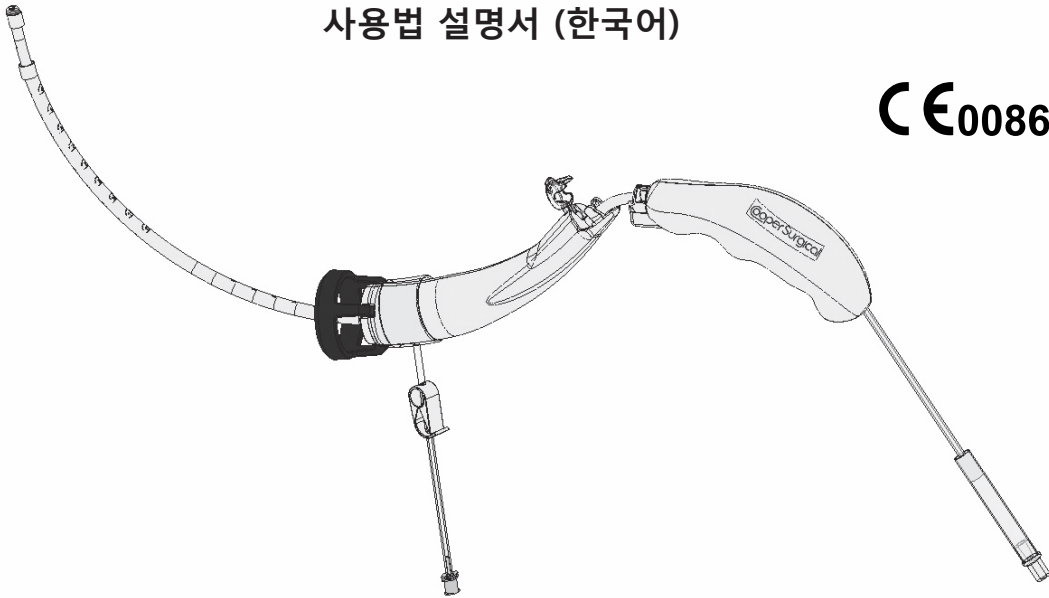

Advincula **DELINEATOR**TM

Uterine Manipulator with Koh-Efficient[®] Technology

AD750-KE25 • AD750-KE30 • AD750-KE35 • AD750-KE40
AD750-KES25 • AD750-KES30 • AD750-KES35 • AD750-KES40

Manipulateur utérin doté de la technologie Koh-Efficient[®]

Manipulador uterino con tecnología Koh-Efficient[®]

Manipolatore uterino con tecnologia Koh-Efficient[®]

Uterusmanipulator mit Koh-Efficient[®] Technologie

Manipulador uterino com tecnologia Koh-Efficient[®]

Uteriene manipulator met Koh-Efficient[®] technologie

Koh-Efficient[®] Teknolojili Rahim Manipulatörü

Koh-Efficient[®] 기술의 자궁거상기

English.....	Page 1
Français / French	Page 6
Español / Spanish.....	Página 11
Italiano / Italian	Pagina 16
Deutsch / German	Seite 21
Português / Portuguese	Página 26
Nederlands / Dutch.....	Pagina 31
Türkçe / Turkish	Sayfa 36
한국어 / Korean.....	페이지 41

Advincula Delineator™ Uterine Manipulator With Koh-Efficient® Technology

Single Use Device for Total Laparoscopic Hysterectomy,
Laparoscopic Assisted Vaginal Hysterectomy
and/or Supra-Cervical Hysterectomy

CE0086

STERILE
SINGLE-USE

Instructions for Use (English)

Device Description/Intended Use

The Advincula Delineator™ Uterine Manipulator is a single-use disposable device designed specifically for Total Laparoscopic Hysterectomy, Laparoscopic Assisted Vaginal Hysterectomy and/or Supra-Cervical Hysterectomy. The Advincula Delineator consists of a tip balloon built into the shaft along with an integrated colpotomy solution known as the Koh-Efficient®. This device comes in three (3) different sizes based on the diameter of the colpotomy cups. There are also versions available with steel cups for use with harmonic scalpel, or laser.

ELECTROCAUTERY VERSION

Part Number	Description
AD750-KE25	Advincula Delineator™ Uterine Manipulator with 2.5 cm Ultem® Koh-Efficient®
AD750-KE30	Advincula Delineator™ Uterine Manipulator with 3.0 cm Ultem® Koh-Efficient®
AD750-KE35	Advincula Delineator™ Uterine Manipulator with 3.5 cm Ultem® Koh-Efficient®
AD750-KE40	Advincula Delineator™ Uterine Manipulator with 4.0 cm Ultem® Koh-Efficient®

HARMONIC SCALPEL OR LASER VERSION

Part Number	Description
AD750-KES25	Advincula Delineator™ Uterine Manipulator with 2.5 cm Stainless Steel Koh-Efficient®
AD750-KES30	Advincula Delineator™ Uterine Manipulator with 3.0 cm Stainless Steel Koh-Efficient®
AD750-KES35	Advincula Delineator™ Uterine Manipulator with 3.5 cm Stainless Steel Koh-Efficient®
AD750-KES40	Advincula Delineator™ Uterine Manipulator with 4.0 cm Stainless Steel Koh-Efficient®

Parts of the Manipulator

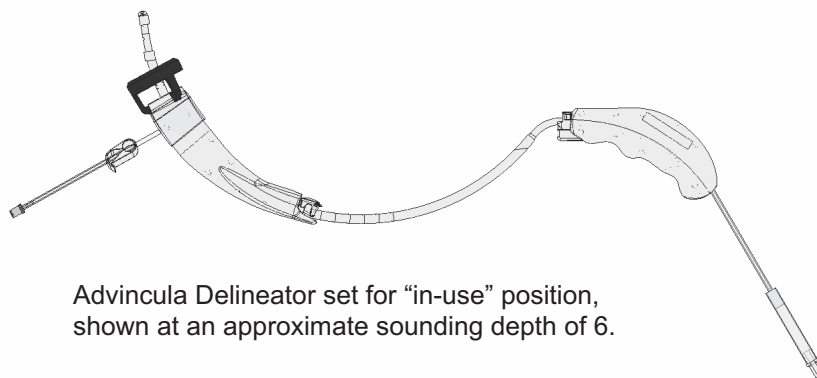
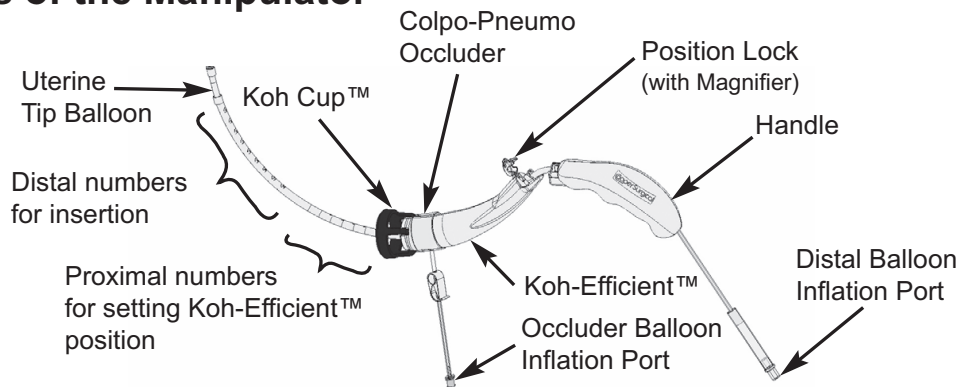

Advincula Delineator set for "in-use" position, shown at an approximate sounding depth of 6.

Indications for Use

The CooperSurgical Advincula Delineator™ Uterine Manipulator is indicated to provide delineation of the vaginal fornices and maintain pneumoperitoneum as a uterine manipulator during Total Laparoscopic Hysterectomy, Laparoscopic Assisted Vaginal Hysterectomy and/or Laparoscopic Supra-Cervical Hysterectomy.

Contraindications

- The Advincula Delineator is to be used only when complete removal of the uterus is intended.
- This disposable manipulator should not be used when an IUD is in place, when the patient is pregnant, or intends to become pregnant.

Warnings

- The Koh colpotomy cups come in two variations; Ultem® plastic for use with electro-surgical devices and stainless steel versions for use with Harmonic Scalpel and Laser. These cups are not interchangeable and should not be used with different, untested energy sources.
- Using an incorrect size Koh Cup could result in patient injury.

Advincula Delineator™ Uterine Manipulator

- Contents supplied sterile.
- Do not use if sterile barrier is damaged.
- Do not use if the device has been opened or damaged.
- Do not over inflate the Uterine Tip Balloon with more than 10 cc of air.
- Always confirm that the Koh-Efficient is locked in place prior to starting the colpotomy.
- For single use only. Do not reuse, reprocess or re-sterilize. Reuse, reprocessing or re-sterilization may compromise the structural integrity of the device and/or lead to device failure which, in turn, may result in patient injury, illness or death. Reuse, reprocessing or re-sterilization may also create a risk of contamination of the device and/or cause patient infection or cross-infection, including, but not limited to, the transmission of infectious disease(s) from one patient to another. Contamination of the device may lead to injury, illness or death of the patient.
- Dispose of in accordance with all applicable Federal, State, and local Medical/Hazardous waste practices.

Caution

U.S. Federal law restricts this device to sale by or on the order of a physician.

Directions for Use

Sounding

1. Using a Uterine Sounding instrument graduated in centimeters (not included), sound the uterus to determine its depth (external OS to Fundus).

Sizing

1. Using a Cervical Sizing instrument, graduated in centimeters (not included), measure the cervical diameter to determine the appropriate size Koh Cup (2.5 cm, 3.0 cm, 3.5 cm or 4.0 cm diameter cup) to use.

Dilation

1. Use a tenaculum (not included) to grasp the lip of the cervix.
2. Using a cervical dilator (not included), dilate the cervix to Hegar/Hank 8 (French 24) to ease manipulator insertion
3. Once complete, open the appropriate Advincula Delineator pouch.

Balloon Test Inflation

1. Test Inflate both balloons (refer to the chart below for air volume amounts).

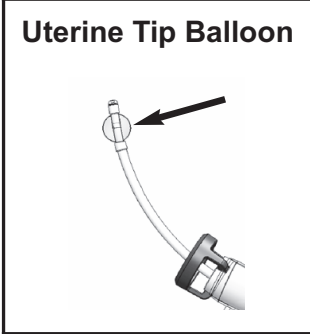
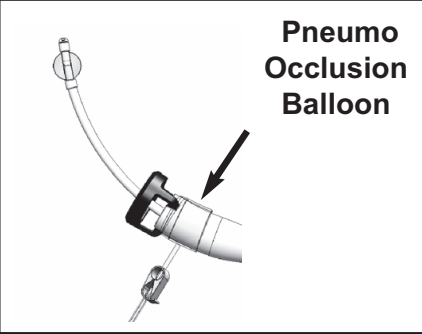
 <p>Uterine Tip Balloon</p>	 <p>Pneumo Occlusion Balloon</p>
<p>Air Volume: 10 cc</p>	<p>Air Volume: 40-60 cc</p>

2. Visually inspect both balloons while they are inflated.
3. Then deflate both balloons completely.

Insertion

1. Use a tenaculum (not included).
2. Slowly insert the tip of the manipulator, to the pre-determined sounding depth using the distal sounding depth numbers on the device.



Distal numbers for insertion

3. Inflate the Uterine Tip Balloon slowly with up to 10 cc of air or until you feel resistance. Remove tenaculum.
4. Using the proximal set of numbers, slide the Koh-Efficient forward to the sounded number and push down on the position lock to secure it in place. Once completely engaged, the clear lens of the position lock should magnify the sounding depth number for enhanced readability.



Proximal numbers for setting Koh-Efficient

5. Once fully inserted confirm visually or by palpation, that the cervix is completely seated into the colpotomy cup.
6. Gently pull on the device to test for proper engagement of the tip in the uterus.

Advincula Delineator™ Uterine Manipulator

7. Just prior to colpotomy, inflate the Pneumo Occlusion Balloon with 60 cc of air. Should loss of pneumoperitoneum occur, up to an additional 60 cc can be added.













Tip Disengagement/Completion

Prior to removing the Advincula Delineator from the uterus, remove air from both the Uterine Tip Balloon and the Pneumo Occlusion Balloon. Discard the device in accordance with your hospital's guidelines.

Storage

Store at room temperature, avoid extreme temperatures.

Explanation of Symbols

 REF	Reorder number		Not made with natural rubber latex
 LOT	Lot number		Do not re-use
	Use-by date		Do not resterilize
 STERILE EO	Sterilized using ethylene oxide		Do not use if package is damaged
	Consult instructions for use		Manufacturer
	Caution		Product conforms to the Medical Device Directive 93/42/EEC
R_x Only	U.S. Federal law restricts this device to sale by or on the order of a physician.	 EC REP	Authorized representative in the European Community

Advincula Delineator™ is a trademark of CooperSurgical, Inc.

Koh-Efficient® is a registered trademark of CooperSurgical, Inc.

Koh Cup™ is a trademark of CooperSurgical, Inc.

Ultem® is a registered trademark of SABIC Global Technologies B.V.

CooperSurgical is a registered trademark of CooperSurgical, Inc.

© 2016 CooperSurgical, Inc.

Manipulateur utérin Advincula Delineator™ doté de la technologie Koh-Efficient®

Dispositif à usage unique pour hystérectomie laparoscopique totale,
hystérectomie vaginale assistée par laparoscopie
et/ou hystérectomie supracervicale

C €0086

USAGE UNIQUE
STÉRILE

Notice d'utilisation (Français)

Description du dispositif/Usage prévu

Le manipulateur utérin Advincula Delineator™ est un dispositif à usage unique jetable conçu pour l'hystérectomie laparoscopique totale, l'hystérectomie vaginale assistée par laparoscopie et/ou l'hystérectomie supracervicale. L'Advincula Delineator se caractérise par un ballonnet d'embout monté sur la tige, ainsi qu'un système de colpotomie intégré appelé Koh-Efficient®. Ce dispositif existe en trois (3) tailles différentes selon le diamètre des coquilles de colpotomie. Il existe aussi des versions avec des coquilles en acier pour un usage avec un scalpel harmonique ou laser.

VERSION POUR ÉLECTROCAUTÉRISATION

Référence	Description
AD750-KE25	Manipulateur utérin Advincula Delineator™ doté d'un Koh-Efficient® de 2,5 cm en polymère Ultem®
AD750-KE30	Manipulateur utérin Advincula Delineator™ doté d'un Koh-Efficient® de 3 cm en polymère Ultem®
AD750-KE35	Manipulateur utérin Advincula Delineator™ doté d'un Koh-Efficient® de 3,5 cm en polymère Ultem®
AD750-KE40	Manipulateur utérin Advincula Delineator™ doté d'un Koh-Efficient® de 4 cm en polymère Ultem®

VERSION POUR SCALPEL HARMONIQUE OU LASER

Référence	Description
AD750-KES25	Manipulateur utérin Advincula Delineator™ doté d'un Koh-Efficient® de 2,5 cm en acier inoxydable
AD750-KES30	Manipulateur utérin Advincula Delineator™ doté d'un Koh-Efficient® de 3 cm en acier inoxydable
AD750-KES35	Manipulateur utérin Advincula Delineator™ doté d'un Koh-Efficient® de 3,5 cm en acier inoxydable
AD750-KES40	Manipulateur utérin Advincula Delineator™ doté d'un Koh-Efficient® de 4 cm en acier inoxydable

Pièces du manipulateur

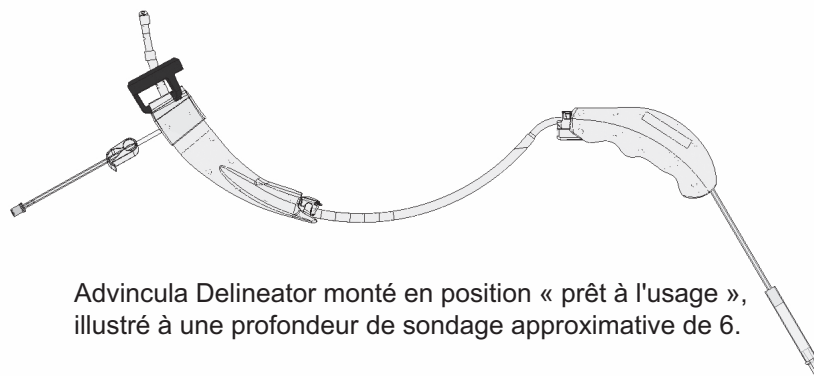
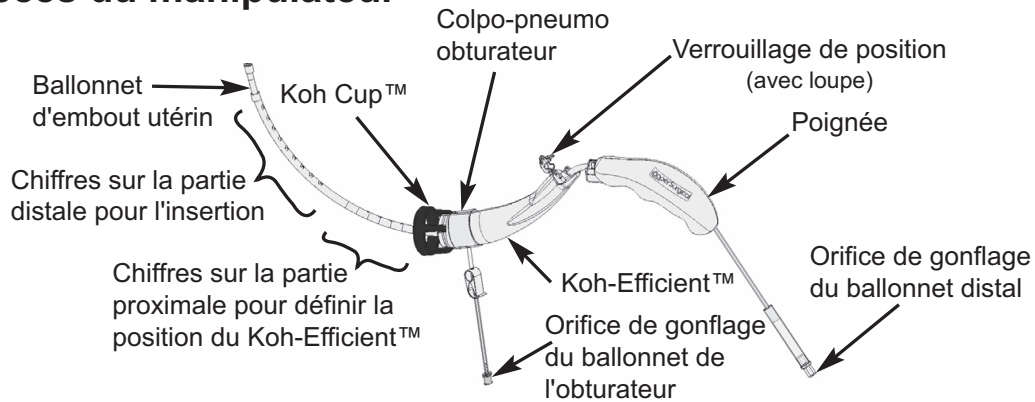

Indications thérapeutiques

Le manipulateur utérin Advincula Delineator de CooperSurgical est indiqué pour fournir la délimitation des culs-de-sac vaginaux et maintenir un pneumopéritoine pendant une hystérectomie laparoscopique totale, une hystérectomie vaginale assistée par laparoscopie et/ou une hystérectomie laparoscopique supracervicale.

Contre-indications

- L'Advincula Delineator est réservé à l'ablation totale de l'utérus.
- Ce manipulateur jetable ne doit pas être utilisé si la patiente porte un stérilet, si elle est enceinte ou prévoit de l'être.

Mises en garde

- Les coquilles de colpotomie Koh se déclinent en deux variantes ; la version en plastique Ultem® pour un usage avec les dispositifs électrochirurgicaux et les versions en acier inoxydable pour un usage avec scalpel harmonique ou laser. Ces coquilles ne sont pas interchangeables, et elles ne doivent pas être utilisées avec des sources d'énergie différentes non testées.

- L'utilisation d'une coquille Koh Cup de taille incorrecte pourrait avoir pour conséquence des lésions graves chez la patiente.
- Contenu fourni stérile.
- Ne pas utiliser si la barrière stérile est abîmée.
- Ne pas utiliser si le dispositif a été ouvert ou qu'il est abîmé.
- Ne pas surgonfler le ballonnet d'embout utérin à plus de 10 cc d'air.
- Toujours confirmer que le Koh-Efficient est bien verrouillé en place avant de commencer la colpotomie.
- Dispositif à usage unique. Ne pas réutiliser, retraiter ni restériliser. La réutilisation, le retraitement ou la restérilisation peuvent porter atteinte à l'intégrité structurelle du dispositif et/ou entraîner sa défaillance, avec pour conséquence des lésions, une maladie, voire le décès de la patiente. La réutilisation, le retraitement ou la restérilisation peuvent également engendrer un risque de contamination du dispositif et/ou provoquer une infection ou une infection croisée chez la patiente, notamment mais non exclusivement, la transmission de maladie(s) infectieuse(s) d'une patiente à une autre. La contamination du dispositif peut être à l'origine de lésions, d'une maladie voire du décès de la patiente.
- Procéder à la mise au rebut conformément à toutes les pratiques d'élimination des déchets médicaux/dangereux nationales, régionales et locales en vigueur.

Attention

En vertu de la loi fédérale des États-Unis, ce dispositif peut être vendu uniquement par un médecin ou sur ordonnance d'un médecin.

Mode d'emploi

Sondage

1. À l'aide d'un instrument de sondage utérin gradué en centimètres (non compris), sonder l'utérus afin de déterminer sa profondeur (depuis l'orifice externe jusqu'au fond utérin).

Calibrage

1. À l'aide d'un calibre cervical gradué en centimètres (non compris), mesurer le diamètre cervical pour déterminer la taille adéquate de la Koh Cup (coquille d'un diamètre de 2,5 cm, 3 cm, de 3,5 cm ou de 4 cm) à utiliser.

Dilatation

1. Saisir la lèvre du col utérin à l'aide d'une pince Tenaculum (non comprise).
2. À l'aide d'un dilateur cervical (non compris), réaliser une dilatation suffisante du col de l'utérus de Hegar/Hank 8 (24 Fr.) pour faciliter l'introduction du manipulateur.
3. Une fois l'opération accomplie, ouvrir la pochette de l'Advincula Delineator qui convient.

Gonflage test des ballonnets

1. Effectuer un test en gonflant les deux ballonnets (voir les quantités de volume d'air dans le tableau ci-dessous).

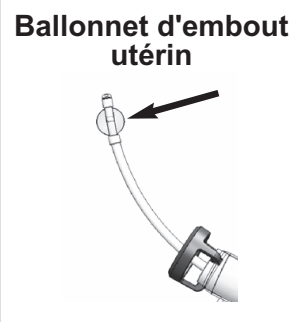
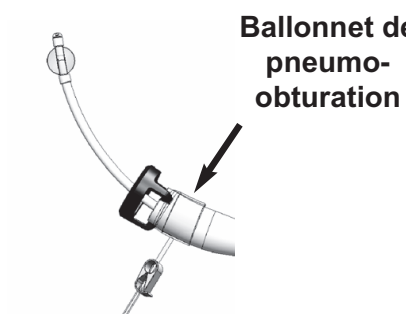
 <p>Ballonnet d'embout utérin</p>	 <p>Ballonnet de pneumo-obturation</p>
<p>Volume d'air : 10 cc</p>	<p>Volume d'air : 40-60 cc</p>

2. Inspecter visuellement les deux ballonnets pendant leur gonflage.
3. Ensuite, dégonfler entièrement les deux ballonnets.

Introduction

1. Utiliser une pince Tenaculum (non comprise).
2. Insérer très lentement l'embout du manipulateur jusqu'à la profondeur de sondage préalablement déterminée en vous aidant des chiffres sur la partie distale du dispositif.



Chiffres sur la partie distale pour l'insertion

3. Gonfler lentement le ballonnet d'embout utérin jusqu'à 10 cc d'air ou jusqu'à sentir une résistance. Retirer la pince Tenaculum.
4. En suivant la série de chiffres sur la partie proximale, glisser le Koh-Efficient vers l'avant jusqu'au chiffre sondé, et appuyer sur le verrouillage de position pour le maintenir en place. Une fois le Koh-Efficient parfaitement enclenché, le chiffre de la profondeur de sondage doit apparaître grossi par la lentille transparente sur le verrouillage de position pour une meilleure lisibilité



Chiffres sur la partie proximale pour définir la position du Koh-Efficient

5. Une fois l'introduction faite, confirmer visuellement ou par palpation que le col de l'utérus est bien en place dans la coquille de colpotomie.

6. Tirer délicatement sur le dispositif pour tester si l'embout est bien enclenché dans l'utérus.
7. Juste avant la colpotomie, gonfler le ballonnet de pneumo-obturation jusqu'à 60 cc d'air. En cas de perte de pneumopéritoine, il est possible de rajouter jusqu'à 60 cc d'air.













Désenclenchement de l'embout/Fin de l'intervention

Avant de retirer l'Advincula Delineator de l'utérus, extraire l'air des deux ballonnets d'embout utérins et du ballonnet de pneumo-obturation. Jeter le dispositif en accord avec les directives de votre hôpital.

Stockage

Stocker à température ambiante. Éviter les températures extrêmes.

Explication des symboles

	Numéro de référence		Exempt de latex de caoutchouc naturel
	Numéro de lot		Ne pas réutiliser
	Date de péremption		Ne pas restériliser
	Stérilisé à l'oxyde d'éthylène		Ne pas utiliser si l'emballage est abîmé
	Consulter la notice d'utilisation		Fabricant
	Attention		Produit conforme à la directive 93/42/EEC relative aux dispositifs médicaux
R_x Only	En vertu de la loi fédérale des États-Unis, ce dispositif peut être vendu uniquement par un médecin ou sur ordonnance d'un médecin.		Représentant agréé dans l'Union européenne

Advincula Delineator™ est une marque de CooperSurgical, Inc.
Koh-Efficient® est une marque déposée de CooperSurgical, Inc.
Koh Cup™ est une marque de CooperSurgical, Inc.
Ultem® est une marque déposée de SABIC Global Technologies B.V.
CooperSurgical est une marque déposée de CooperSurgical, Inc.

© 2016 CooperSurgical, Inc.

Manipulador uterino Advincula Delineator™ con tecnología Koh-Efficient®

Dispositivo de un solo uso para histerectomía laparoscópica total,
histerectomía laparoscópica vaginal asistida
y/o histerectomía supracervical

CE0086

ESTÉRIL DE
UN SOLO USO

Instrucciones de uso (Español)

Descripción del dispositivo/Usos previstos

El manipulador uterino Advincula Delineator™ es un dispositivo desechable de un solo uso diseñado específicamente para histerectomía laparoscópica total, histerectomía laparoscópica vaginal asistida y/o histerectomía supracervical. El Advincula Delineator consta de un balón de punta integrado en el eje junto con una solución de colpotomía integrada conocida como Koh-Efficient®. Este dispositivo se presenta en tres (3) tamaños diferentes según el diámetro de las copas de colpotomía. También existen versiones disponibles con copas de acero para uso con escalpelo armónico o láser.

VERSIÓN DE ELECTROCAUTERIZACIÓN

Número de pieza	Descripción
AD750-KE25	Manipulador uterino Advincula Delineator™ con Ultem® Koh-Efficient® de 2,5 cm.
AD750-KE30	Manipulador uterino Advincula Delineator™ con Ultem® Koh-Efficient® de 3 cm.
AD750-KE35	Manipulador uterino Advincula Delineator™ con Ultem® Koh-Efficient® de 3,5 cm.
AD750-KE40	Manipulador uterino Advincula Delineator™ con Ultem® Koh-Efficient® de 4 cm.

VERSIÓN PARA ESCALPELO ARMÓNICO O LÁSER

Número de pieza	Descripción
AD750-KES25	Manipulador uterino Advincula Delineator™ con Koh-Efficient® de acero de 2,5 cm.
AD750-KES30	Manipulador uterino Advincula Delineator™ con Koh-Efficient® de acero de 3 cm.
AD750-KES35	Manipulador uterino Advincula Delineator™ con Koh-Efficient® de acero de 3,5 cm.
AD750-KES40	Manipulador uterino Advincula Delineator™ con Koh-Efficient® de acero de 4 cm.

Partes del manipulador

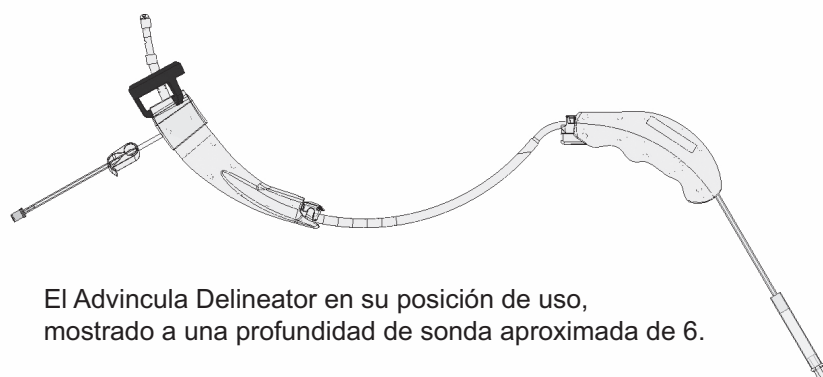
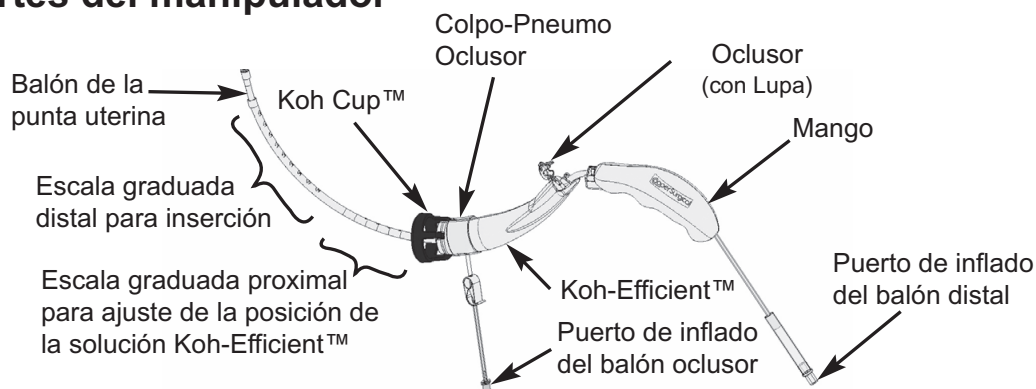

Instrucciones de uso

El manipulador uterino Advincula Delineator de CooperSurgical está indicado para proporcionar una delineación de los fórnix vaginales y mantener el pneumoperitoneo como manipulador uterino durante una histerectomía laparoscópica total, una histerectomía laparoscópica vaginal asistida y/o una histerectomía laparoscópica supracervical.

Contraindicaciones

- El Advincula Delineator solo se debe usar cuando esté previsto realizar una extracción completa del útero.
- Este manipulador desechable no se debe usar cuando la paciente lleve colocado un DIU, cuando esté embarazada, o si tiene la intención de quedarse embarazada.

Advertencias

- Las copas Koh de colpotomía se presentan en dos variantes: en plástico Ultem® para uso con dispositivos electroquirúrgicos y en versiones en acero inoxidable para uso con escalpo armónico y láser. Estas copas no son intercambiables y no se deben usar con fuentes de energía diferentes no probadas.
- El uso de una copa Koh de tamaño incorrecto puede provocar lesiones a la paciente.

- El contenido se suministra esterilizado.
- No lo utilice si la barrera estéril está dañada.
- No lo utilice si el dispositivo ha sido abierto o está dañado.
- No infle en exceso el balón de la punta uterina con más de 10 cc de aire.
- Confirme siempre que la solución Koh-Efficient está bloqueada en posición antes de comenzar la colpotomía.
- Para un solo uso. No volver a usar, volver a procesar ni volver a esterilizar. La reutilización, reprocesado o reesterilización podrían comprometer la integridad estructural del dispositivo y/o producir un fallo del dispositivo que, a su vez, podría producir lesiones, enfermedades, o la muerte de la paciente. La reutilización, reprocesado o reesterilización también podrían producir un riesgo de contaminación del dispositivo y/o provocar a la paciente infección o infección cruzada, incluyendo, pero sin limitarse a ello, la transmisión de enfermedades infecciosas de una paciente a otra. La contaminación del dispositivo puede producir lesiones, enfermedades o la muerte de la paciente.
- Deséchelo según todas las normas y prácticas federales, estatales y locales aplicables a residuos peligrosos/médicos.

Precaución

De acuerdo con las leyes federales estadounidenses, este dispositivo solo puede ser adquirido por un médico o bajo órdenes suyas.

Modo de empleo

Sondeo

1. Usando un instrumento de sondeo uterino graduado en centímetros (no se incluye), sondee el útero para determinar su profundidad (del os externo al fondo).

Medición de tamaño

1. Usando un instrumento de medición de tamaño del útero, graduado en centímetros (no se incluye), mida el diámetro cervical para determinar el tamaño adecuado de la copa Koh (2,5 cm, 3 cm, 3,5 cm o 4 cm de diámetro) que hay que usar.

Dilatación

1. Utilice un tenáculo (no se incluye) para asir el labio del cuello uterino.
2. Con un dilatador cervical (no se incluye) dilate el cuello del útero hasta 8 Hegar/Hank (24 French) para facilitar la inserción del manipulador.
3. Cuando haya completado esto, abra la bolsa del Advincula Delineator adecuada.

Inflado de prueba del balón

1. Realice un inflado de prueba de ambos balones (consulte la tabla siguiente para ver las cantidades de volumen de aire).

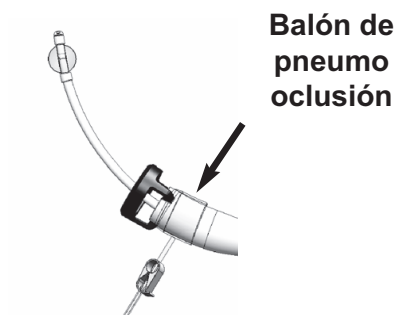
 <p>Balón de la punta uterina</p>	 <p>Balón de pneumo oclusión</p>
<p>Volumen de aire: 10 cc</p>	<p>Volumen de aire: 40-60 cc</p>

2. Inspeccione visualmente ambos balones mientras se inflan.
3. Desinfe totalmente ambos balones.

Inserción

1. Utilice un tenáculo (no se incluye).
2. Inserte lentamente la punta en el manipulador hasta la profundidad de sondeo predeterminada usando la escala graduada de sondeo distal del dispositivo.



Escala graduada distal para inserción

3. Infle lentamente el balón de la punta uterina con hasta 10 cc de aire o hasta que encuentre resistencia. Retire el tenáculo.
4. Con ayuda de la escala graduada proximal, deslice la solución Koh-Efficient hacia adelante hasta el número sondado y baje el bloqueo de posición para fijarla en su lugar. Una vez totalmente acoplada, la lente transparente del bloqueo de posición debe aumentar el número de la profundidad de sondeo para mejorar su lectura.



Proximal numbers for setting Koh-Efficient

5. Una vez totalmente insertado, confirme visualmente o mediante palpación que el cuello uterino está completamente asentado en la copa de colpotomía.

Manipulador uterino Advincula Delineator™

6. Tire suavemente del dispositivo para comprobar si la punta se ha acoplado debidamente en el útero.
7. Inmediatamente antes de la colpotomía, infle el balón de pneumo oclusión con 60 cc de aire. Si ocurriera la pérdida del pneumoperitoneo, se pueden añadir hasta 60 cc adicionales.















Desacoplamiento de la punta/terminación

Antes de retirar el Advincula Delineator del útero, elimine el aire tanto del balón de la punta uterina como del balón de pneumo oclusión. Deseche el dispositivo según las directrices de su hospital.

Almacenamiento

Almacenar a temperatura ambiente, evitando temperaturas extremas.

Explicación de los símbolos

	Número para nuevo pedido		No está fabricado con látex de caucho natural
	Número de lote		No volver a usar
	Fecha de uso preferente		No volver a esterilizar
	Esterilizado mediante óxido de etileno		No lo utilice si el envase está dañado
	Consulte las instrucciones de uso		Fabricante
	Precaución		Producto conforme a la Directiva 93/42/CEE sobre Productos Sanitarios
	De acuerdo con las leyes federales estadounidenses, este dispositivo solo puede ser adquirido por un médico o bajo órdenes suyas.		Representante autorizado en la Comunidad Europea

Advincula Delineator™ es una marca comercial de CooperSurgical, Inc.

Koh-Efficient® es una marca comercial registrada de CooperSurgical, Inc.

Koh Cup™ es una marca comercial de CooperSurgical, Inc.

Ultem® es una marca comercial registrada de SABIC Global Technologies B.V.

CooperSurgical es una marca registrada de CooperSurgical, Inc.

© 2016 CooperSurgical, Inc.

Manipolatore uterino Advincula Delineator™ con tecnologia Koh-Efficient®

Dispositivo monouso per isterectomia laparoscopica totale,
isterectomia vaginale laparoscopicamente assistita
e/o isterectomia sopracervicale

CE0086

STERILE
MONOUSO

Istruzioni per l'uso (Italiano)

Descrizione/uso previsto del dispositivo

Il manipolatore uterino Advincula Delineator™ è un dispositivo monouso appositamente studiato per isterectomia laparoscopica totale, isterectomia vaginale laparoscopicamente assistita e/o isterectomia sopracervicale. Il manipolatore uterino Advincula Delineator è costituito da un palloncino per punta incorporato nell'asta con una soluzione per colpotomia integrata nota con il nome di Koh-Efficient®. Il dispositivo è disponibile in tre (3) diverse dimensioni in base al diametro delle coppette per colpotomia. Sono disponibili anche versioni con coppette in acciaio per l'utilizzo con bisturi armonico o laser.

VERSIONE PER ELETTROCAUSTICAZIONE

Numero pezzo	Descrizione
AD750-KE25	Manipolatore uterino Advincula Delineator™ con Koh-Efficient® da 2,5 cm in Ultem®
AD750-KE30	Manipolatore uterino Advincula Delineator™ con Koh-Efficient® da 3 cm in Ultem®
AD750-KE35	Manipolatore uterino Advincula Delineator™ con Koh-Efficient® da 3,5 cm in Ultem®
AD750-KE40	Manipolatore uterino Advincula Delineator™ con Koh-Efficient® da 4 cm in Ultem®

VERSIONE PER BISTURI ARMONICO O LASER

Numero pezzo	Descrizione
AD750-KES25	Manipolatore uterino Advincula Delineator™ con Koh-Efficient® da 2,5 cm in acciaio inossidabile
AD750-KES30	Manipolatore uterino Advincula Delineator™ con Koh-Efficient® da 3 cm in acciaio inossidabile
AD750-KES35	Manipolatore uterino Advincula Delineator™ con Koh-Efficient® da 3,5 cm in acciaio inossidabile
AD750-KES40	Manipolatore uterino Advincula Delineator™ con Koh-Efficient® da 4 cm in acciaio inossidabile

Componenti del manipolatore

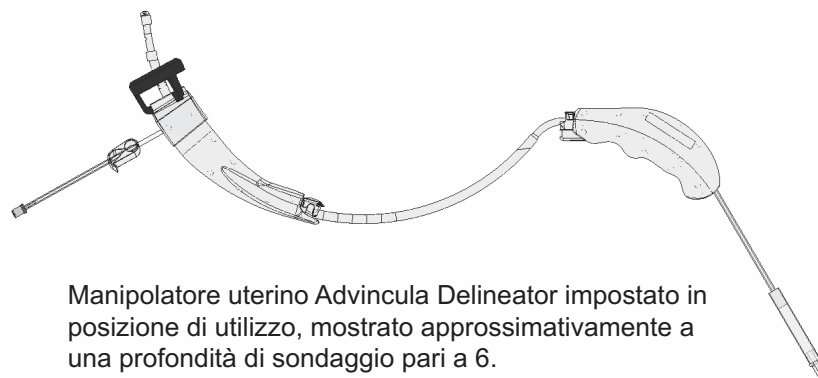
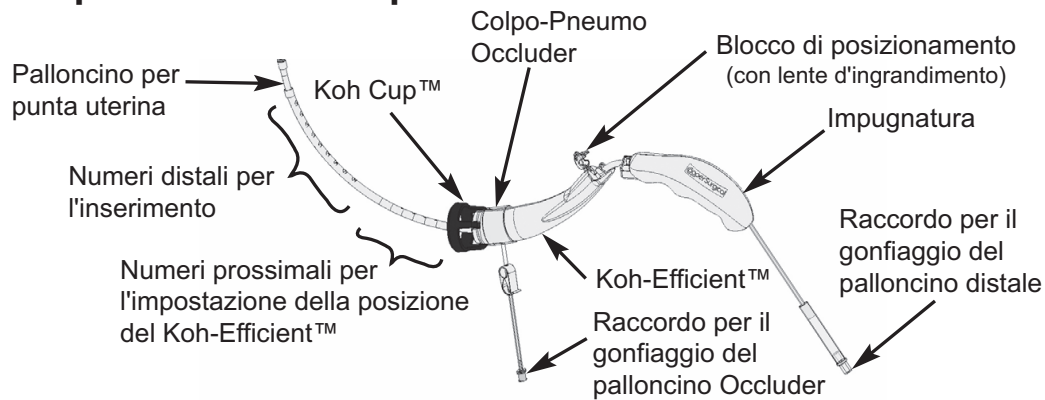

Indicazioni d'uso

Il manipolatore uterino CooperSurgical Advincula Delineator è indicato per delineare i fornici vaginali e mantenere lo pneumoperitoneo come manipolatore uterino durante un'isterectomia laparoscopica totale, un'isterectomia vaginale laparoscopicamente assistita e/o un'isterectomia sopracervicale.

Controindicazioni

- Il manipolatore uterino Advincula Delineator deve essere utilizzato solo nei casi in cui è prevista la completa asportazione dell'utero.
- Il manipolatore monouso non deve essere utilizzato nelle pazienti che hanno impiantato uno IUD, in quelle in stato di gravidanza o che progettano una gravidanza.

Avvertenze

- Le coppette per colpotomia Koh sono disponibili in due versioni: la versione in plastica Ultem® per l'utilizzo con dispositivi elettrochirurgici e la versione in acciaio inossidabile per l'utilizzo con bisturi armonico e laser. Le coppette non sono intercambiabili e non devono essere utilizzate con fonti di energia diverse non testate.

- L'utilizzo di una coppetta Koh Cup di dimensioni non corrette potrebbe causare lesioni alla paziente.
- Contenuto fornito sterile.
- Non utilizzare se la barriera sterile è danneggiata.
- Non utilizzare se il dispositivo è stato aperto o danneggiato.
- Prima di iniziare la colpotomia confermare sempre che il Koh-Efficient sia bloccato in sede.
- Dispositivo monouso. Non riutilizzare, non ritrattare, né risterilizzare. L'eventuale riutilizzo, ritrattamento o risterilizzazione potrebbe compromettere l'integrità strutturale del dispositivo e/o causarne la rottura, con conseguenti lesioni, malattie o decesso della paziente. L'eventuale riutilizzo, ritrattamento o risterilizzazione può inoltre creare un rischio di contaminazione del dispositivo e/o causare alla paziente infezioni o infezioni incrociate, tra cui, a titolo non esaustivo, trasmissione di malattie infettive da una paziente all'altra. La contaminazione del dispositivo può causare lesioni, malattie o decesso della paziente.
- Smaltire nel rispetto di tutte le procedure applicabili in materia di rifiuti sanitari/pericolosi previste dalle normative federali, statali e locali.

Attenzione

Le leggi federali degli Stati Uniti consentono la vendita di questo dispositivo solo da parte di un medico o su prescrizione di un medico.

Istruzioni per l'uso

Sondaggio

1. Con l'ausilio di una sonda uterina graduata in centimetri (non inclusa), sondare l'utero per determinarne la profondità (dall'orifizio esterno al fondo).

Dimensionamento

1. Con l'ausilio di un misuratore per cervice graduato in centimetri (non incluso), misurare il diametro della cervice per determinare la coppetta Koh Cup delle dimensioni più appropriate da utilizzare (diametro della coppetta 2,5 cm, 3 cm, 3,5 cm o 4 cm).

Dilatazione

1. Utilizzare un tenacolo (non incluso) per afferrare il margine della cervice.
2. Con l'ausilio di un dilatatore per cervice (non incluso), dilatare la cervice fino a 8 Hegar/Hank (24 French) per agevolare l'inserimento del manipolatore.
3. Una volta completata l'operazione, aprire il sacchetto Advincula Delineator appropriato.

Gonfiaggio di prova del palloncino

1. Eseguire il gonfiaggio di prova di entrambi i palloncini (fare riferimento allo schema sottostante per i volumi d'aria).

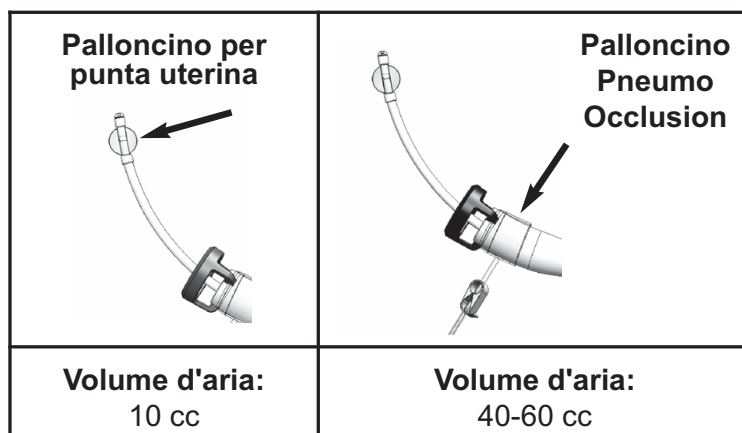

2. Eseguire un controllo visivo di entrambi i palloncini durante il gonfiaggio.
3. Eseguire lo sgonfiaggio completo di entrambi i palloncini.

Inserimento

1. Utilizzare un tenacolo (non incluso).
2. Inserire lentamente la punta del manipolatore fino alla profondità di sondaggio predeterminata usando i numeri della profondità di sondaggio distale sul dispositivo.



Numeri distali per l'inserimento

3. Gonfiare lentamente il palloncino per punta uterina con un volume d'aria massimo pari a 10 cc o fino a quando si avverte una certa resistenza. Rimuovere il tenacolo.
4. Utilizzando la serie di numeri prossimali, far scorrere il Koh-Efficient verso il numero sondato e spingerlo verso il basso sul blocco di posizionamento per fissarlo in posizione. Una volta fissato completamente, la lente trasparente del blocco di posizionamento dovrebbe ingrandire il numero della profondità di sondaggio per una migliore leggibilità.



Numeri prossimali per l'impostazione del Koh-Efficient

- Una volta inserito completamente, confermare visivamente o tramite palpazione che la cervice sia interamente posizionata all'interno della coppetta per colpotomia.
- Tirare con cautela il dispositivo per verificare il corretto posizionamento della punta nell'utero.
- Prima della colpotomia, gonfiare il palloncino Pneumo Occlusion con 60 cc di aria. In caso di perdita dello pneumoperitoneo, è possibile aggiungere ulteriori 60 cc di aria.













Completamento/rimozione della punta

Prima di rimuovere il manipolatore uterino Advincula Delineator dall'utero rimuovere l'aria sia dal palloncino per punta uterina che dal palloncino Pneumo Occlusion. Smaltire il dispositivo in conformità alle linee guida della struttura ospedaliera.

Conservazione

Conservare a temperatura ambiente, evitare l'esposizione a temperature estreme.

Spiegazione dei simboli

	Numero per nuovo ordine		Privo di lattice naturale
	Numero lotto		Non riutilizzare
	Data di scadenza		Non risterilizzare
	Sterilizzato con ossido di etilene		Non utilizzare se la confezione è danneggiata
	Consultare le istruzioni per l'uso		Produttore
	Attenzione		Prodotto conforme alla Direttiva sui dispositivi medici 93/42/CEE
R_x Only	Le leggi federali degli Stati Uniti consentono la vendita di questo dispositivo solo da parte di un medico o su prescrizione di un medico.		Rappresentante autorizzato nella Comunità Europea

Advincula Delineator™ è un marchio di CooperSurgical, Inc.
Koh-Efficient® è un marchio registrato di CooperSurgical, Inc.
Koh Cup™ è un marchio di CooperSurgical, Inc.
Ultem® è un marchio registrato di SABIC Global Technologies B.V.
CooperSurgical è un marchio registrato di CooperSurgical, Inc.

© 2016 CooperSurgical, Inc.

Advincula Delineator™ Uterusmanipulator mit Koh-Efficient® Technologie

Einwegprodukt für laparoskopische totale Hysterektomie,
laparoskopisch assistierte vaginale Hysterektomie
und/oder suprazervikale Hysterektomie

C €0086

STERIL, EINMAL
VERWENDBAR

Gebrauchsanweisung (Deutsch)

Produktbeschreibung/Verwendungszweck

Der Advincula Delineator™ Uterusmanipulator ist ein Einwegprodukt, das speziell für die laparoskopische totale Hysterektomie, die laparoskopisch assistierte vaginale Hysterektomie und/oder die suprazervikale Hysterektomie entwickelt wurde. Der Advincula Delineator besteht aus einem im Schaft integrierten Ballon an der Spitze der Vorrichtung in Kombination mit einer integrierten Kolpotomie-Lösung, die als Koh-Efficient® bekannt ist. Diese Vorrichtung ist basierend auf dem Durchmesser der Kolpotomie-Cups in drei (3) verschiedenen Größen erhältlich. Für den Gebrauch mit einem harmonischen Skalpell oder Laser sind Ausführungen mit Edelstahl-Cups erhältlich.

AUSFÜHRUNG FÜR ELEKTROKAUTER

Bestellnummer	Beschreibung
AD750-KE25	Advincula Delineator™ Uterusmanipulator mit 2,5 cm Ultem® Koh-Efficient®
AD750-KE30	Advincula Delineator™ Uterusmanipulator mit 3 cm Ultem® Koh-Efficient®
AD750-KE35	Advincula Delineator™ Uterusmanipulator mit 3,5 cm Ultem® Koh-Efficient®
AD750-KE40	Advincula Delineator™ Uterusmanipulator mit 4 cm Ultem® Koh-Efficient®

AUSFÜHRUNG FÜR HARMONISCHES SKALPELL ODER LASER

Bestellnummer	Beschreibung
AD750-KES25	Advincula Delineator™ Uterusmanipulator mit 2,5 cm Koh-Efficient® aus Edelstahl
AD750-KES30	Advincula Delineator™ Uterusmanipulator mit 3 cm Koh-Efficient® aus Edelstahl
AD750-KES35	Advincula Delineator™ Uterusmanipulator mit 3,5 cm Koh-Efficient® aus Edelstahl
AD750-KES40	Advincula Delineator™ Uterusmanipulator mit 4 cm Koh-Efficient® aus Edelstahl

Bestandteile des Manipulators

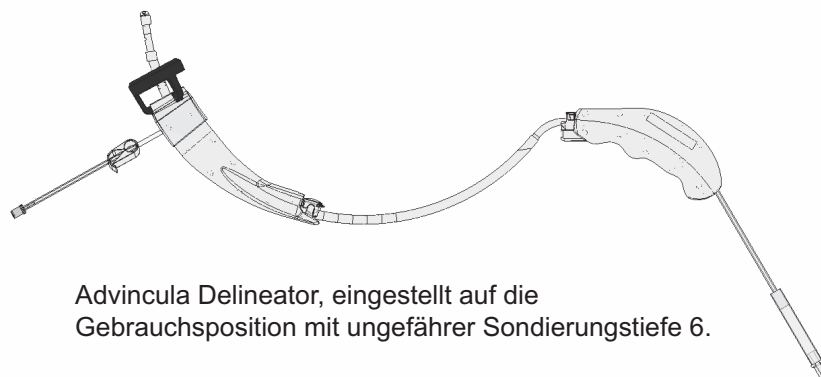
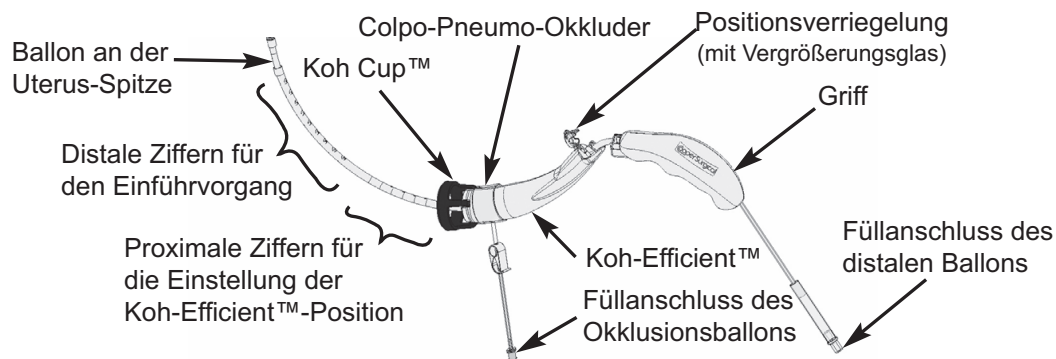

Indikationen

Der CooperSurgical Advincula Delineator Uterusmanipulator ist für die Abgrenzung des Scheidengewölbes und die Herstellung eines Pneumoperitoneums bei der laparoskopischen totalen Hysterektomie, der laparoskopisch assistierten vaginalen Hysterektomie und/oder der suprazervikalen Hysterektomie indiziert.

Kontraindikationen

- Der Advincula Delineator darf nur verwendet werden, wenn die vollständige Entfernung des Uterus vorgesehen ist.
- Dieser Einweg-Manipulator darf nicht verwendet werden, wenn ein IUP eingesetzt ist, wenn die Patientin schwanger ist oder wenn die Patientin beabsichtigt, schwanger zu werden.

Warnhinweise

- Die Koh-Kolpotomie-Cups sind in zwei Varianten erhältlich: aus Ultem®-Kunststoff für den Gebrauch mit elektrochirurgischen Geräten und aus Edelstahl für den Gebrauch mit einem harmonischen Skalpell oder Laser. Diese Cups sind nicht untereinander austauschbar und dürfen nicht mit anderen, ungeprüften Energiequellen verwendet werden.
- Die Verwendung eines Koh Cup mit ungeeigneter Größe kann zur Verletzung der Patientin führen.

- Die enthaltenen Artikel sind steril.
- Nicht verwenden, falls die Sterilbarriere beschädigt ist.
- Bei geöffneter oder beschädigtem Produkt nicht verwenden.
- Den Ballon an der Uterus-Spitze nicht mit mehr als 10 cm³ Luft aufdehnen.
- Stets bestätigen, dass der Koh-Efficient in der gewünschten Position verriegelt ist, bevor mit der Kolpotomie begonnen wird.
- Nur für den Einmalgebrauch. Nicht wiederverwenden, wiederaufbereiten oder resterilisieren. Eine Wiederverwendung, Wiederaufbereitung oder Resterilisation kann die strukturelle Integrität der Vorrichtung beeinträchtigen bzw. zum Versagen der Vorrichtung führen. Dies kann wiederum zu Verletzungen, Erkrankungen oder zum Tod der Patientin führen. Eine Wiederverwendung, Wiederaufbereitung oder Resterilisation kann außerdem das Risiko einer Kontaminierung der Vorrichtung entstehen lassen bzw. zu einer Infektion oder Kreuzinfektion von Patientinnen führen, d. h. u. a. die Übertragung von Infektionskrankheiten von einer Patientin zur anderen. Eine Kontaminierung der Vorrichtung kann zu Verletzungen, Erkrankungen oder zum Tod der Patientin führen.
- Gemäß den vor Ort geltenden Vorschriften für medizinische/gefährliche Abfälle entsorgen.

Vorsicht

Gemäß den Vorschriften des US-amerikanischen Bundesgesetzes darf dieses Medizinprodukt nur durch oder auf Veranlassung eines Arztes verkauft werden.

Gebrauchsanweisung

Sondierung

1. Die Tiefe des Uterus (äußerer Muttermund zum Fundus) mit einem Gebärmutter-Sondierungsinstrument mit Zentimeter-Graduierung (nicht mitgeliefert) bestimmen.

Größenbestimmung

1. Den Durchmesser der Zervix mit einem Zervix-Sizer mit Zentimeter-Graduierung (nicht mitgeliefert) messen, um die erforderliche Größe des zu verwendenden Koh Cup (2,5 cm, 3 cm, 3,5 cm oder 4 cm Durchmesser) zu bestimmen.

Dilatation

1. Die Lippe der Zervix mit einer Fasszange (nicht mitgeliefert) ergreifen.
2. Die Zervix mit einem Zervixdilator (nicht mitgeliefert) auf 8 Hegar/Hank (24 French) aufdehnen, um das Einführen des Manipulators zu erleichtern.
3. Anschließend den Beutel des entsprechenden Advincula Delineator öffnen.

Testaufdehnung der Ballons

1. Beide Ballons zur Prüfung der Unversehrtheit aufdehnen (siehe nachfolgende Abbildung bzgl. des korrekten Luftvolumens).

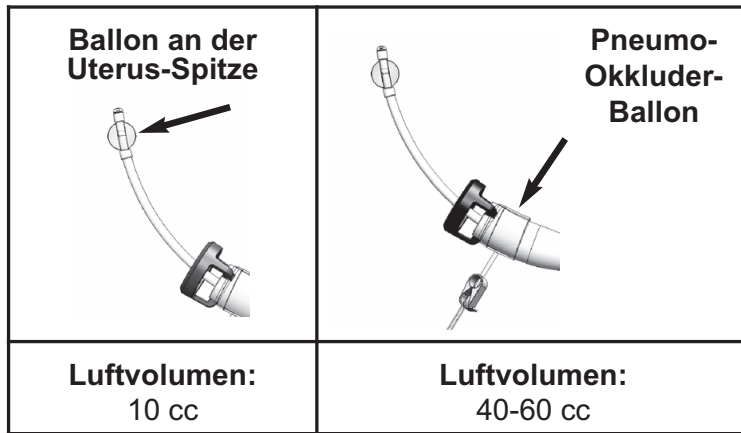

2. Beide Ballons im aufgedehnten Zustand visuell prüfen.
3. Danach beide Ballons wieder vollständig entleeren.

Einführung

1. Eine Faszange (nicht mitgeliefert) verwenden.
2. Die Spitze des Manipulators unter Verwendung der distalen



Distale Ziffern für den Einführvorgang

Sondierungstiefenziffern an der Vorrichtung langsam auf die vorher bestimmte Sondierungstiefe einführen.

3. Den Ballon an der Uterus-Spitze langsam mit bis zu 10 cm³ Luft (oder bis Widerstand zu spüren ist) aufdehnen. Die Faszange entfernen.
4. Den Koh-Efficient unter Verwendung des proximalen Ziffernsatzes zur vorher bestimmten Sondierungstiefenziffer vorschieben und auf die Positionsverriegelung drücken, um die eingestellte Sondierungstiefe zu verriegeln. Nach vollständiger Verriegelung der Position zeigt das Vergrößerungsglas der Positionsverriegelung die Sondierungstiefenziffer groß an, um die Ablesbarkeit zu verbessern.



Proximale Ziffern für die Einstellung der Koh-Efficient-Position

Advincula Delineator™ Uterusmanipulator

5. Nachdem der Manipulator vollständig eingeführt wurde, visuell oder durch Abtasten bestätigen, dass die Zervix vollständig im Kolpotomie-Cup positioniert ist.
6. Vorsichtig an der Vorrichtung ziehen, um den ordnungsgemäßen Sitz der Spitze im Uterus zu bestätigen.
7. Unmittelbar vor der Kolpotomie den Pneumo-Okkluder-Ballon mit 60 cm³ Luft aufdehnen. Sollte das Pneumoperitoneum verloren gehen, können bis zu 60 cm³ Luft hinzugefügt werden.













Lösen der Spitze/Abschluss des Verfahrens

Vor dem Entfernen des Advincula Delineator aus dem Uterus die Luft sowohl aus dem Ballon an der Uterus-Spitze als auch aus dem Pneumo-Okkluder-Ballon entfernen. Die Vorrichtung entsprechend den Richtlinien des Krankenhauses entsorgen.

Lagerung

Bei Zimmertemperatur lagern. Extreme Temperaturen vermeiden.

Erläuterung der Symbole

	Bestellnummer		Nicht mit Naturlatex hergestellt
	Losnummer		Nicht wiederverwenden
	Verfallsdatum		Nicht resterilisieren
	Mit Ethylenoxid sterilisiert		Bei beschädigter Verpackung nicht verwenden
	Gebrauchsanweisung beachten		Hersteller
	Vorsicht		Produkt entspricht der Medizinprodukte-Richtlinie 93/42/EWG
R_x Only	Gemäß den Vorschriften des US-amerikanischen Bundesgesetzes darf dieses Medizinprodukt nur durch oder auf Veranlassung eines Arztes verkauft werden.		Bevollmächtigter Vertreter in der Europäischen Gemeinschaft

Advincula Delineator™ ist eine Marke von CooperSurgical, Inc.

Koh-Efficient® ist eine eingetragene Marke von CooperSurgical, Inc.

Koh Cup™ ist eine Marke von CooperSurgical, Inc.

Ultem® ist eine eingetragene Marke von SABIC Global Technologies B.V.

CooperSurgical ist eine eingetragene Marke von CooperSurgical, Inc.

© 2016 CooperSurgical, Inc.

Manipulador uterino Advincula Delineator™ com tecnologia Koh-Efficient®

Dispositivo descartável para histerectomia laparoscópica total,
histerectomia vaginal assistida por laparoscopia

C **€0086**

e/ou histerectomia supracervical

UTILIZAÇÃO ÚNICA
ESTERILIZADA

Instruções de utilização (Português)

Descrição/utilização prevista do dispositivo

O manipulador uterino Advincula Delineator™ é um dispositivo descartável de utilização única concebido especificamente para a histerectomia laparoscópica total, histerectomia vaginal assistida por laparoscopia e/ou histerectomia supracervical. O Advincula Delineator consiste num balão de ponta incorporado na haste juntamente com uma solução de colpotomia integrada conhecida por Koh-Efficient®. Este dispositivo é fornecido em três (3) tamanhos diferentes com base no diâmetro dos copos de colpotomia. Existem igualmente versões disponíveis com copos em aço para a utilização com bisturi harmónico ou laser.

VERSÃO DE ELETROCAUTÉRIO

Número de peça	Descrição
AD750-KE25	Manipulador uterino Advincula Delineator™ com Ultem® Koh-Efficient® de 2,5 cm
AD750-KE30	Manipulador uterino Advincula Delineator™ com Ultem® Koh-Efficient® de 3 cm
AD750-KE35	Manipulador uterino Advincula Delineator™ com Ultem® Koh-Efficient® de 3,5 cm
AD750-KE40	Manipulador uterino Advincula Delineator™ com Ultem® Koh-Efficient® de 4 cm

VERSÃO DE BISTURI HARMÓNICO OU LASER

Número de peça	Descrição
AD750-KES25	Manipulador uterino Advincula Delineator™ com Koh-Efficient® em aço inoxidável de 2,5 cm
AD750-KES30	Manipulador uterino Advincula Delineator™ com Koh-Efficient® em aço inoxidável de 3 cm
AD750-KES35	Manipulador uterino Advincula Delineator™ com Koh-Efficient® em aço inoxidável de 3,5 cm
AD750-KES40	Manipulador uterino Advincula Delineator™ com Koh-Efficient® em aço inoxidável de 4 cm

Peças do manipulador

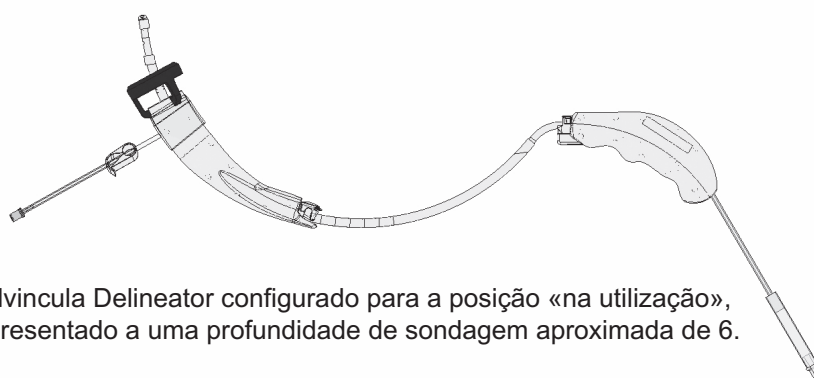
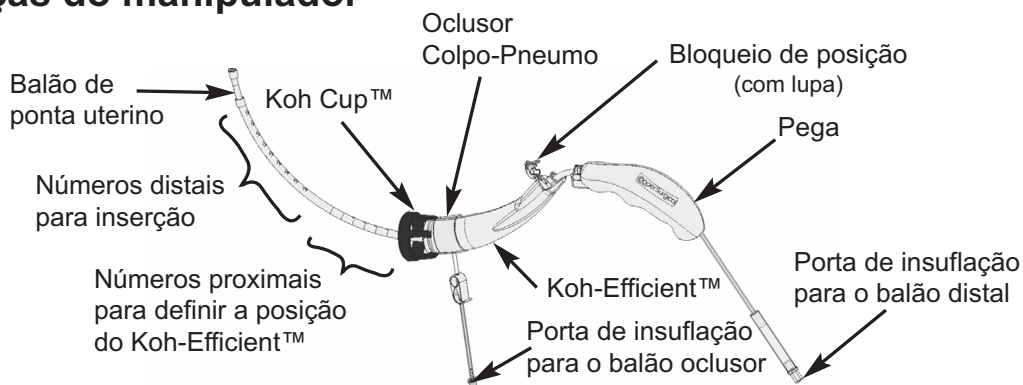

Advincula Delineator configurado para a posição «na utilização», apresentado a uma profundidade de sondagem aproximada de 6.

Indicações de utilização

O manipulador uterino Advincula Delineator da CooperSurgical é indicado para delinear os fôrnices vaginais e manter o pneumoperitônio como manipulador uterino durante a histerectomia laparoscópica total, histerectomia vaginal assistida por laparoscopia e/ou histerectomia supracervical.

Contraindicações

- O Advincula Delineator apenas deve ser utilizado quando está prevista a remoção total do útero.
- Este manipulador descartável não deve ser utilizado quando está colocado um DIU, quando a paciente está grávida, ou tenciona engravidar.

Avisos

- Os copos de colpotomia Koh são fornecidos em duas variantes; versões de plástico Ultem® para a utilização com dispositivos eletrocirúrgicos e de aço inoxidável para a utilização com bisturi harmónico e laser. Estes copos não são permutáveis e não devem ser utilizados com fontes de energia diferentes não testadas.
- A utilização de um Koh Cup com tamanho incorreto poderá resultar em ferimentos na paciente.

- Os conteúdos são fornecidos esterilizados.
- Não utilizar, se a barreira estéril estiver danificada.
- Não utilizar, se o dispositivo tiver sido aberto ou danificado.
- Não encher o balão de ponta uterino com mais de 10 cm³ de ar.
- Confirmar sempre que o Koh-Efficient está bloqueado antes de iniciar a colpotomia.
- Apenas para uma única utilização. Não reutilizar, reprocessar, ou reesterilizar. A reutilização, reprocessamento ou reesterilização podem comprometer a integridade estrutural do dispositivo e/ou conduzir à falha do dispositivo que, por sua vez, pode resultar em lesão, doença ou morte do paciente. A reutilização, reprocessamento ou reesterilização podem também criar um risco de contaminação do dispositivo e/ou causar a infecção ou infecção cruzada no paciente, incluindo, entre outros, a transmissão de doença(s) infecciosa(s) de um paciente para outro. A contaminação do dispositivo pode conduzir a lesão, doença, ou morte do paciente.
- Eliminar de acordo com todas as práticas federais, estaduais e locais em matéria de resíduos hospitalares/perigosos.

Precaução

A lei federal americana restringe a venda deste dispositivo apenas a médicos ou a alguém por eles mandatado.

Instruções de utilização

Sondagem

1. Com a utilização de um instrumento de sondagem uterina graduado em centímetros (não incluído), sondar o útero para determinar a sua profundidade (do orifício externo do útero até ao fundo).

Medição

1. Com a utilização de um medidor cervical, graduado em centímetros (não incluído), medir o diâmetro cervical para determinar o tamanho adequado do Koh Cup (copo com 2,5 cm, 3 cm, 3,5 cm ou 4 cm de diâmetro) a utilizar.

Dilatação

1. Utilizar um tenáculo (não incluído) para segurar o lábio do colo uterino.
2. Com a utilização de um dilatador cervical (não incluído), dilatar o colo uterino para Hegar/Hank 8 (French 24) de modo a facilitar a inserção do manipulador.
3. Depois de concluído, abrir a bolsa adequada do Advincula Delineator.

Teste de insuflação do balão

1. Efetuar o teste de insuflação em ambos os balões (consultar a tabela em baixo em relação às quantidades de volume de ar).

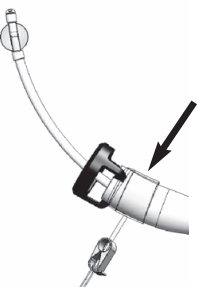
 <p>Balão de ponta uterino</p>	 <p>Balão oclisor de pneumoperitônio</p>
<p>Volume de ar: 10 cm³</p>	<p>Volume de ar: 40-60 cm³</p>

2. Inspeccionar visualmente ambos os balões enquanto são insuflados.
3. De seguida, esvaziar completamente ambos os balões.

Inserção

1. Utilizar um tenáculo (não incluído).
2. Inserir lentamente a ponta do manipulador, até à profundidade de sondagem pré-determinada, utilizando os números distais para a profundidade de sondagem no dispositivo.



Números distais para inserção

3. Encher lentamente o balão de ponta uterino com, no máximo, 10 cm³ de ar ou até sentir resistência. Remover o tenáculo.
4. Com a utilização do conjunto de números proximais, desloque o Koh-Efficient em direção ao número sondado e pressione o bloqueio de posição para o fixar. Depois de completamente colocado, a lente transparente do bloqueio de posição deve ampliar o número de profundidade de sondagem para melhorar a sua legibilidade.



Números proximais para colocar o Koh-Efficient

5. Depois de totalmente inserido, confirmar visualmente ou por palpação que o colo uterino esteja totalmente inserido no copo de colpotomia.
6. Puxar cuidadosamente o dispositivo para testar a colocação correta da ponta no útero.

Manipulador uterino Advincula Delineator™

7. Imediatamente antes da colpotomia, encher o balão ocluser de pneumoperitônio com 60 cm³ de ar. Caso haja perda de pneumoperitônio, é possível adicionar, no máximo, 60 cm³.















Retirada da ponta/Conclusão

Antes de remover o Advincula Delineator do útero, retirar o ar do balão de ponta uterino e do balão ocluser de pneumoperitônio. Eliminar o dispositivo de acordo com as orientações do hospital.

Conservação

Conservar à temperatura ambiente, evitar temperaturas extremas.

Explicação de símbolos

	Número de referência		Não fabricado com látex de borracha natural
	Número do lote		Não reutilizar
	Prazo de validade		Não reesterilizar
	Esterilizado através de óxido de etileno		Não utilizar se a embalagem estiver danificada
	Consultar as instruções de utilização		Fabricante
	Precaução		O produto está conforme a Diretiva 93/42/CEE relativa aos dispositivos médicos
	A lei federal americana restringe a venda deste dispositivo apenas a médicos ou a alguém por eles mandatado.		Representante autorizado na Comunidade Europeia

Advincula Delineator™ é uma marca comercial da CooperSurgical, Inc.
Koh-Efficient® é uma marca comercial da CooperSurgical, Inc.
Koh Cup™ é uma marca comercial da CooperSurgical, Inc.
Ultem® é uma marca comercial da SABIC Global Technologies B.V.
CooperSurgical é uma marca comercial registrada da CooperSurgical, Inc.

© 2016 CooperSurgical, Inc.

Advincula Delineator™ uteriene manipulator met Koh-Efficient® technologie

Hulpmiddel voor eenmalig gebruik bij volledige laparoscopische hysterectomie, vaginale hysterectomie met laparoscopie en/of supracervicale hysterectomie

C €0086

STERIEL EENMALIG
GEBRUIK

Gebruiksaanwijzingen (Nederlands)

Beschrijving hulpmiddel en beoogd gebruik

De Advincula Delineator™ uteriene manipulator is een hulpmiddel voor eenmalig gebruik, specifiek ontworpen voor een volledige laparoscopische hysterectomie, vaginale hysterectomie met laparoscopie en/of supracervicale hysterectomie. De Advincula Delineator bestaat uit een tipballon ingebouwd in de schacht samen met een geïntegreerde colpotomie-oplossing gekend als de Koh-Efficient®. Het hulpmiddel komt in drie (3) verschillende maten op basis van de diameter van de colpotomiecup. Er zijn ook versies beschikbaar met stalen cups voor gebruik met harmonische scalpel of laser.

ELEKTROCAUTERISATIE VERSIE

Onderdeelnummer	Beschrijving
AD750-KE25	Advincula Delineator™ uteriene manipulator met 2,5 cm Ultem® Koh-Efficient®
AD750-KE30	Advincula Delineator™ uteriene manipulator met 3 cm Ultem® Koh-Efficient®
AD750-KE35	Advincula Delineator™ uteriene manipulator met 3,5 cm Ultem® Koh-Efficient®
AD750-KE40	Advincula Delineator™ uteriene manipulator met 4 cm Ultem® Koh-Efficient®

HARMONISCHE SCALPEL OF LASER VERSIE

Onderdeelnummer	Beschrijving
AD750-KES25	Advincula Delineator™ uteriene manipulator met 2,5 cm roestvrijstalen Koh-Efficient®
AD750-KES30	Advincula Delineator™ uteriene manipulator met 3 cm roestvrijstalen Koh-Efficient®
AD750-KES35	Advincula Delineator™ uteriene manipulator met 3,5 cm roestvrijstalen Koh-Efficient®
AD750-KES40	Advincula Delineator™ uteriene manipulator met 4 cm roestvrijstalen Koh-Efficient®

Onderdelen van de manipulator

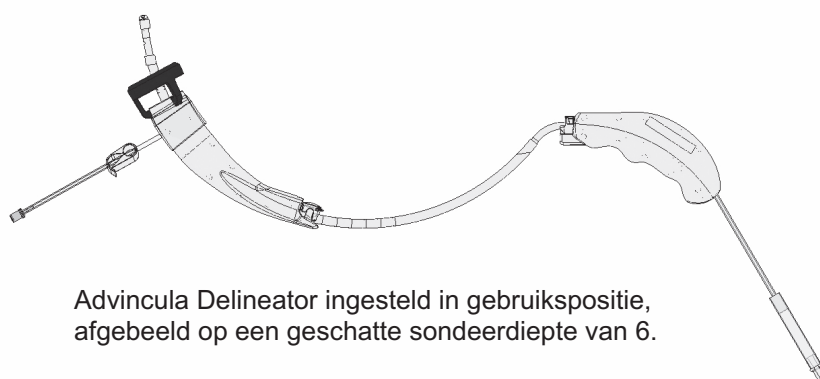
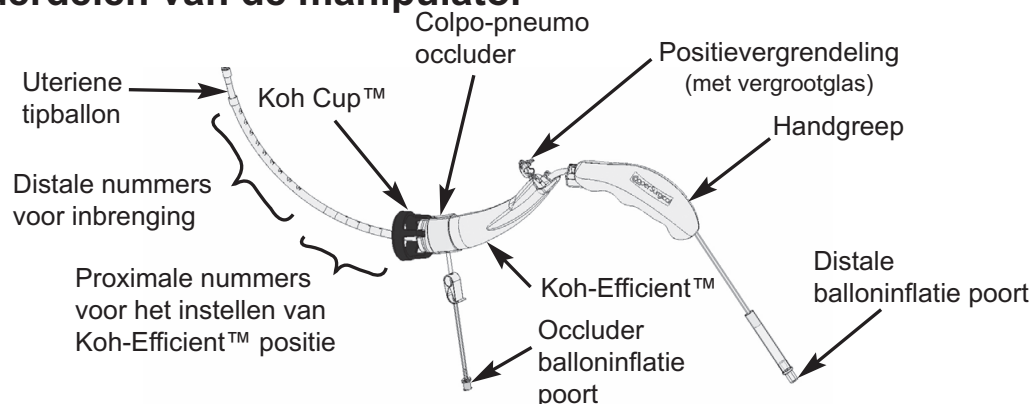

Gebruiksindicaties

De CooperSurgical Advincula Delineator uteriene manipulator is geïndiceerd om afbakening van de vaginale fornices te verschaffen en pneumoperitoneum te handhaven als uteriene manipulator bij volledige laparoscopische hysterectomie, vaginale hysterectomie met laparoscopie en/of supracervicale hysterectomie.

Contra-indicaties

- De Advincula Delineator mag alleen worden gebruikt bij volledige verwijdering van de baarmoeder.
- Deze wegwerpbare manipulator mag niet worden gebruikt bij aanwezigheid van een spiraaltje, als de patiënt zwanger is of van plan is zwanger te worden.

Waarschuwingen

- Er zijn twee soorten Koh colpotomiecup: de plastic Ultem® voor gebruik met elektrochirurgische apparaten en een roestvrijstalen versie voor gebruik met de harmonische scalpel en laser. Deze cups zijn niet verwisselbaar zijn en mogen niet worden gebruikt met verschillende, ongeteste energiebronnen.

- Bij gebruik van de onjuiste Koh cup maat kan de patiënt een letsel oplopen.
- Inhoud steriel geleverd.
- Niet gebruiken indien de steriele barrière beschadigd is.
- Niet gebruiken indien het hulpmiddel beschadigd of reeds geopend is.
- Vul de uteriene tipballon met niet meer dan 10 cc lucht.
- Zorg er steeds voor dat de Koh-Efficient is vergrendeld vóór het starten van de colpotomie.
- Uitsluitend voor eenmalig gebruik. Niet opnieuw gebruiken, opnieuw verwerken of opnieuw steriliseren. Hergebruik, opwerking of opnieuw steriliseren kan de structurele integriteit van het hulpmiddel beschadigen en/of leiden tot defecten van het hulpmiddel die op hun beurt tot letsel, ziekte of overlijden van de patiënt kunnen leiden. Hergebruik, opwerking of opnieuw steriliseren kan ook een risico op besmetting van het hulpmiddel met zich meebrengen en/of leiden tot infectie of kruisinfectie van de patiënt waaronder, maar niet beperkt tot, de overdracht van besmettelijke ziekte(n) van de ene op de andere patiënt. Besmetting van het hulpmiddel kan leiden tot letsel, ziekte of overlijden van de patiënt.
- Verwerk in overeenstemming met alle van toepassing zijnde federale, staats- en lokale medische voorschriften en voorschriften voor gevaarlijk afval.

Opgelet

Volgens de Amerikaanse federale wetgeving mag dit hulpmiddel uitsluitend door of op voorschrift van een arts worden verkocht.

Gebruiksaanwijzingen

Sonderen

1. Gebruik van een uterinen sonderingsinstrument gegradueerd in centimeters (niet inbegrepen), sondeer de baarmoeder om zijn diepte te bepalen (externe OS naar Fundus).

Afmeting

1. Met behulp van een cervicaal meetinstrument gegradueerd in centimeters (niet inbegrepen) meet de cervicale diameter om de juiste Koh cup maat te bepalen (diameter cup 2,5 cm, 3 cm; 3,5 cm of 4 cm) voor gebruik.

Dilatatie

1. Gebruik een tenaculum (niet inbegrepen) om de lip van de baarmoederhals vast te pakken.
2. Met behulp van een cervicale dilator, verwijdt de baarmoederhals tot 8 Hegar/Hank (24 French) om het inbrengen van de manipulator te vergemakkelijken.
3. Zodra voltooid, open de juiste Advincula Delineator verpakking.

Test inflatie ballon

1. Test het vullen van beide ballonnen (raadpleeg onderstaande tabel voor luchtvolumehoeveelheden).

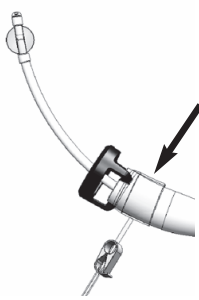
 <p>Uteriene tipballon</p>	 <p>Pneumo-occlusie ballon</p>
<p>Luchtvolume: 10 cc</p>	<p>Luchtvolume: 40-60 cc</p>

2. Inspecteer beide ballonnen visueel terwijl ze worden gevuld.
3. Laat beide ballonnen vervolgens helemaal leeg.

Inbrenging

1. Gebruik een tenaculum (niet inbegrepen).
2. Breng de tip van de manipulator langzaam in tot de vooraf bepaalde sondeerdiepte, met behulp van de nummers van de distale sondeerdiepte op het hulpmiddel.



Distale nummers voor inbrenging

3. Vul de uteriene tipballon langzaam met maximum 10 cc lucht of totdat u weerstand voelt. Verwijder tenaculum.
4. Met de proximale nummers, schuif de Koh-Efficient naar voren naar het sondeernummer en duw naar beneden op de positievergrendeling om op zijn plaats vast te leggen. Zodra volledig ingebracht, zal de doorzichtige lens van de positievergrendeling het nummer van de sondeerdiepte vergroten voor een grotere leesbaarheid.



Proximale nummers voor het instellen van Koh-Efficient

5. Zodra volledig ingebracht, bevestig visueel of door palpatie dat de baarmoederhals volledig in de colpotomiecup is geplaatst.
6. Trek voorzichtig aan het hulpmiddel om te testen of de tip goed is vastgezet in de baarmoeder.

7. Net voor de colpotomie, vul de pneumo-occlusie ballon met 60 cc lucht. Bij verlies van pneuoperitoneum mag er tot een bijkomende 60 cc worden toegevoegd.

Loslaten tip/voltooiing

Vóór het verwijderen van de Advincula Delineator uit de baarmoeder, verwijder de lucht uit zowel de uteriene tipballon als de pneumo-occlusie ballon. Gooi het hulpmiddel weg in overeenstemming met de richtlijnen van uw hospitaal.

Storage

Bewaar op kamertemperatuur. Vermijd extreme temperaturen.

Verklaring van de symbolen

	Bestelnummer		Niet gemaakt van natuurlijk rubber (latex)
	Lotnummer		Niet hergebruiken
	Uiterste houdbaarheidsdatum		Niet opnieuw steriliseren
	Gesteriliseerd met ethyleenoxide		Niet gebruiken indien de verpakking beschadigd is
	Raadpleeg de gebruiksaanwijzing		Fabrikant
	Opgelet		Product voldoet aan de Richtlijn Medische Hulpmiddelen 93/42/EEG
R_x Only	Volgens de Amerikaanse federale wetgeving mag dit hulpmiddel uitsluitend door of op voorschrift van een arts worden verkocht.		Geautoriseerde vertegenwoordiger in de Europese Gemeenschap

Advincula Delineator™ is een handelsmerk van CooperSurgical, Inc.
Koh-Efficient® is een geregistreerd handelsmerk van CooperSurgical, Inc.
Koh Cup™ is een handelsmerk van CooperSurgical, Inc.
Ultem® is een geregistreerd handelsmerk van SABIC Global Technologies B.V.
CooperSurgical is een geregistreerd handelsmerk van CooperSurgical, Inc.

© 2016 CooperSurgical, Inc.

Koh-Efficient® Teknolojili Advincula Delineator™ Rahim Manipülatörü

Total Laparoskopik Histerektomi,
Laparoskopi Destekli Vajinal Histerektomi
ve/veya Supra-Servikal Histerektomi

CE0086

STERİL, TEK
KULLANIMLIK

Kullanım Talimatları (Türkçe)

Açıklaması/Kullanım Amacı

Advincula Delineator™ Rahim Manipülatörü, özel olarak Total Laparoskopik Histerektomi, Laparoskopi Destekli Vajinal Histerektomi ve/veya Supra-Servikal Histerektomi için tasarlanmış, tek kullanımlık bir cihazdır. Advincula Delineator, Koh-Efficient® olarak bilinen entegre kolpotomi çözümü ile birlikte şafta eklenmiş bir uç balon içerir. Bu cihaz, kolpotomi kabı çapına bağlı olarak üç (3) farklı boyutta sunulur. Ayrıca uyumlu bisturi veya lazer ile birlikte kullanım için çelik kaplı sürümler de bulunmaktadır.

ELEKTROKOTER SÜRÜMÜ

Parça Numarası	Açıklama
AD750-KE25	2,5 cm Ultem® Koh-Efficient® Teknolojili Advincula Delineator™ Rahim Manipülatörü
AD750-KE30	3 cm Ultem® Koh-Efficient® Teknolojili Advincula Delineator™ Rahim Manipülatörü
AD750-KE35	3,5 cm Ultem® Koh-Efficient® Teknolojili Advincula Delineator™ Rahim Manipülatörü
AD750-KE40	4 cm Ultem® Koh-Efficient® Teknolojili Advincula Delineator™ Rahim Manipülatörü

HUYUMLU BİSTÜRİ VEYA LAZER SÜRÜMÜ

Parça Numarası	Açıklama
AD750-KES25	2,5 cm Paslanmaz Çelik Koh-Efficient® Teknolojili Advincula Delineator™ Rahim Manipülatörü
AD750-KES30	3 cm Paslanmaz Çelik Koh-Efficient® Teknolojili Advincula Delineator™ Rahim Manipülatörü
AD750-KES35	3,5 cm Paslanmaz Çelik Koh-Efficient® Teknolojili Advincula Delineator™ Rahim Manipülatörü
AD750-KES40	4 cm Paslanmaz Çelik Koh-Efficient® Teknolojili Advincula Delineator™ Rahim Manipülatörü

Manipülatörün Parçaları

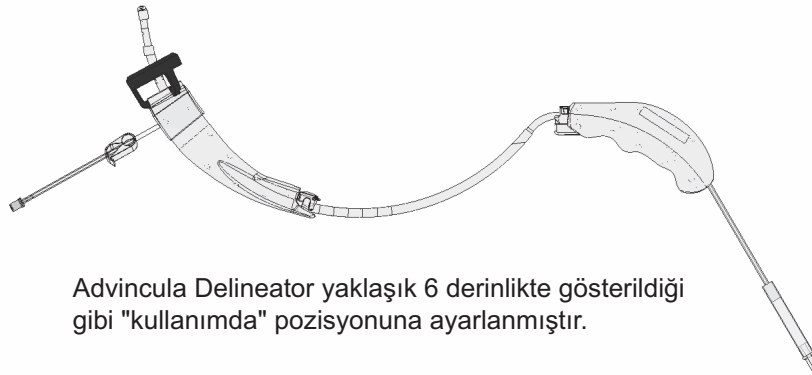
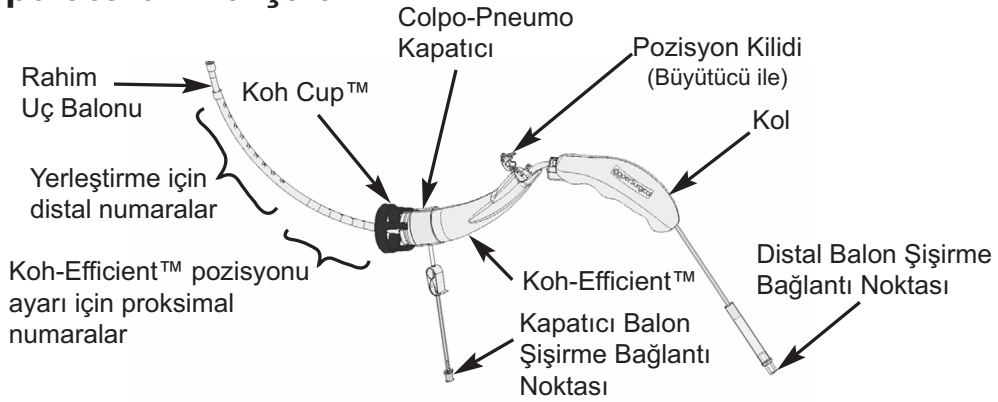

Kullanım Endikasyonları

CooperSurgical Advincula Delineator Rahim Manipülatörü, Total Laparoskopik Histerektomi, Laparoskopik Destekli Vajinal Histerektomi ve/veya Supra-Servikal Histerektomi sırasında rahim manipülatörü olarak vajina tavanı sınırlarını belirlemek ve pnömoperitoneumu sağlamak için endikedir.

Kontrendikasyonlar

- Advincula Delineator, yalnızca rahim tamamen alınacağında kullanılmak üzere tasarlanmıştır.
- Bu tek kullanımlık manipülatör, bir rahim içi araç mevcut olduğunda, hasta hamile olduğunda veya hamile kalmaya çalıştığında kullanılmamalıdır.

Uyarılar

- Koh kolpotomi kapları iki farklı şekilde sunulur; Elektro cerrahi cihazlar ile birlikte kullanım için Ultem® plastiği ve Uyumlu Bisturi ve Lazer kullanımı için paslanmaz çelik. Bu kaplar birbiri yerine kullanılamaz ve farklı, test edilmemiş enerji kaynakları ile birlikte kullanılmamalıdır.
- Yanlış büyüklükte Koh Cup kullanımı, hastanın yaralanmasına neden olabilir.

- İçerik, steril olarak sağlanır.
- Steril bariyeri hasarlıysa kullanmayın.
- Cihaz açılmış veya hasar görmüşse kullanmayın.
- Rahim Uç Balonunu 10cc'den fazla hava kullanarak aşırı şişirmeyin.
- Kolpotomiye başlamadan önce her zaman Koh-Efficient'in yerine sabitlendiğinden emin olun.
- Yalnızca tek kullanımlıktır. Yeniden kullanmayın, yeniden işleme almayın veya yeniden sterilize etmeyin. Yeniden kullanım, yeniden işleme alma veya yeniden sterilize etme, hastanın yaralanmasına, hastalanmasına veya ölmesine yol açabilecek şekilde cihazın yapısal bütünlüğüne zarar verebilir ve/veya cihazın arızalanmasına yol açabilir. Yeniden kullanım, yeniden işleme alma veya yeniden sterilize etme, aynı zamanda cihazda kontaminasyon riski oluşturur ve/veya hastada enfeksiyon ya da sınırlama olmaksızın bulaşıcı hastalıkların bir hastadan diğerine bulaşması da dahil olmak üzere çapraz enfeksiyon görülmesine neden olabilir. Cihaz kontaminasyonu, hastanın yaralanmasına, hastalanmasına veya ölmesine neden olabilir.
- Yürürlükteki tüm Federal kanunlar, Devlet Kanunları ve yerel Tıbbi/Tehlikeli atık uygulamalarına uygun şekilde tasfiye edin.

Dikkat

UABD Federal kanunları bu cihazın yalnızca bir doktor tarafından ya da doktor talimatıyla satılmasına izin vermektedir.

Kullanım Talimatları

Sondaj

1. Santimetreler halinde işaretlenmiş bir Rahim Sondaj aletini (ürünle birlikte verilmez), rahim derinliğini (Dıştan en içe kadar) belirlemek üzere kullanın.

Boyut belirleme

1. Santimetreler halinde işaretlenmiş bir Servikal Boyut belirleme aleti (ürünle birlikte verilmez) kullanarak kullanılacak uygun Koh Cup boyutunu (2,5 cm, 3 cm, 3,5 cm veya 4 cm çaplı kap) belirlemek için servikal çapı ölçün.

Dilasyon

1. Serviksin dudak kısmını kavramak için bir tenakulum (ürünle birlikte verilmez) kullanın.
2. Bir servikal dilatör (ürünle birlikte verilmez) kullanarak, manipülatör yerleşimini kolaylaştırmak için serviksi 8 Hegar/Hank (24 French) değerine kadar genişletin.
3. Tamamlandıktan sonra, uygun Advincula Delineator kesesini açın.

Balon Şişirme Testi

1. Her iki balonu da test amaçlı olarak şişirin (hava hacim değerleri için aşağıdaki çizelgeye göz atın).

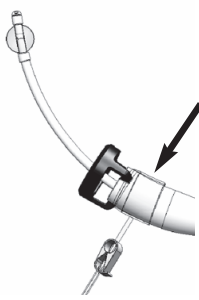
Rahim Uç Balonu 	Pneumo Kapatma Balonu 
Hava Hacmi: 10 cc	Hava Hacmi: 40-60 cc

2. Şişirilmiş durumdayken her iki balonu da gözle denetleyin.
3. Ardından her iki balonun havasını da tamamen boşaltın.

Yerleştirme

1. Bir tenakulum (ürünle birlikte verilmez) kullanın.
2. Cihaz üzerindeki distal derinlik numaralarını kullanarak, manipülatorün ucunu yavaşça önceden belirlenmiş derinliğe yerleştirin.



Yerleştirme için distal numaralar

3. Rahim Uç Balonunu yavaşça 10 cc hava ile veya direnç hissedene kadar şişirin. Tenakulumu çıkarın.
4. Proksimal numara setini kullanarak Koh-Efficient aletini sondaj numarasına kadar kaydırarak getirin ve yerine sabitlemek için pozisyon kilidine bastırın. Eksiksiz bağlantı sağlandıktan sonra, pozisyon kilidinin şeffaf lensi, okunabilirliği iyileştirmek üzere sondaj derinlik numarasını büyütmelidir.



Koh-Efficient ayarı için proksimal numaralar

5. Tamamen yerleşim sağlandıktan sonra, görsel olarak ya da elle muayene ederek serviksin kolpotomi kabına tamamen oturduğundan emin olun.

Advincula Delineator™ Rahim Manipülatörü

- Rahim ucunun yerine uygun şekilde oturup oturmadığını test etmek için cihazı nazıkçe çekin.
- Kolpotominin hemen öncesinde, Pneumo Kapatma Balonunu 60 cc hava kullanarak şişirin. Pnömoreperitoneum kaybı oluşması durumunda 60 cc'ye kadar ilave hava sağlanabilir.













Uç Çıkarma/Tamamlama

Advincula Delineator ürününü rahimden çıkarmadan önce hem Rahim Uç Balonu hem de Pneumo Kapatma Balonunun havasını boşaltın. Cihazı hastanenizin kılavuz ilkelerine uygun şekilde tasfiye edin.

Depolama

Oda sıcaklığında saklayın, aşırı sıcak ve soğuk ortamlardan kaçının.

Simgelerin Açıklaması

	Yeniden sipariş numarası		Doğal kauçuk lateksten yapılmamıştır
	Parti numarası		Yeniden kullanmayın
	Son kullanım tarihi		Yeniden sterilize etmeyin
	Etilen oksit kullanılarak sterilize edilmiştir		Ambalaj hasarlıysa kullanmayın
	Kullanım talimatlarına başvurun		Üretici
	Dikkat		Ürün Tıbbi Cihaz Direktifi 93/42/EEC'ye uygundur
	ABD Federal kanunları bu cihazın yalnızca bir doktor tarafından ya da doktor talimatıyla satılmasına izin vermektedir.		Avrupa topluluğunda yetkili temsilci

Advincula Delineator™, CooperSurgical, Inc'in ticari markasıdır.
Koh-Efficient®, CooperSurgical, Inc'in tescilli ticari markasıdır.
Koh Cup™, CooperSurgical, Inc'in ticari markasıdır.
Ultem®, SABIC Global Technologies B.V'nin tescilli ticari markasıdır.
CooperSurgical, CooperSurgical, Inc'in tescilli ticari markasıdır.

© 2016 CooperSurgical, Inc.

Koh-Efficient® 기술의 Advincula Delineator™ 자궁거상기

복강경하 전자궁절제술, 복강경하 질식 전자궁절제술
및/또는 자궁경부위 자궁절제술용
일회용 장치

CE0086

멸균 일회용

사용법 설명서(한국어)

장치 설명/용도

Advincula Delineator™ 자궁거상기는 복강경하전자궁절제술, 복강경하 질식 전자궁절제술 및/또는 자궁경부위 자궁절제술용으로 특별히 고안된 일회용 장치입니다. Advincula Delineator는 Koh-Efficient®로 알려진 통합 질절개 솔루션과 함께 줄기에 구축된 말단풍선으로 구성되어 있습니다. 이 장치는 질절개 컵의 직경에 따라 크기가 3개입니다. 초음파 절삭기, 또는 레이저와 사용할 수 있는 스틸 컵 버전도 이용할 수 있습니다.

전기소작술 버전

부품 번호	설명
AD750-KE25	2.5cm Ultem® Koh-Efficient®의 Advincula Delineator™ 자궁거상기
AD750-KE30	3.0cm Ultem® Koh-Efficient®의 Advincula Delineator™ 자궁거상기
AD750-KE35	3.5cm Ultem® Koh-Efficient®의 Advincula Delineator™ 자궁거상기
AD750-KE40	4.0cm Ultem® Koh-Efficient®의 Advincula Delineator™ 자궁거상기

초음파 절삭기 또는 레이저 버전

부품 번호	설명
AD750-KES25	2.5cm 스테인리스강 Koh-Efficient®의 Advincula Delineator™ 자궁거상기
AD750-KES30	3.0cm 스테인리스강 Koh-Efficient®의 Advincula Delineator™ 자궁거상기
AD750-KES35	3.5cm 스테인리스강 Koh-Efficient®의 Advincula Delineator™ 자궁거상기
AD750-KES40	4.0cm 스테인리스강 Koh-Efficient®의 Advincula Delineator™ 자궁거상기

거상기 부품

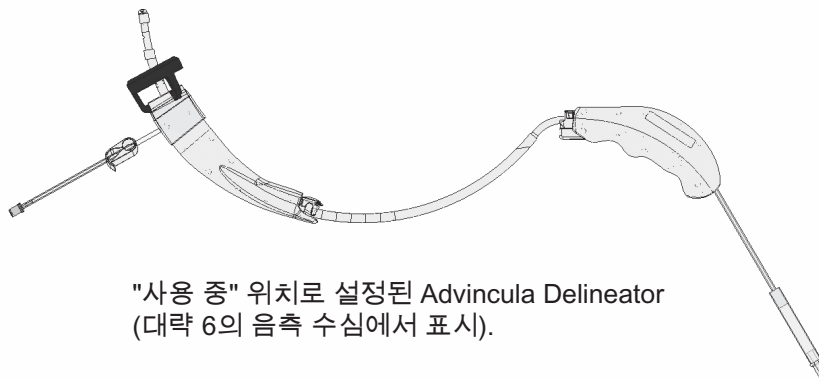
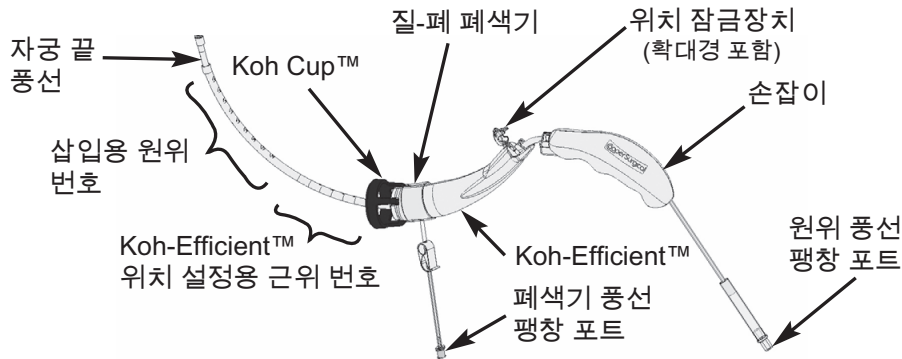

사용 목적

CooperSurgical Advincula Delineator 자궁거상기는복강경하 전자궁절제술, 복강경하 질식 전자궁절제술및/또는 자궁경부위 자궁절제술 중 자궁거상기로질원개의 윤곽을 제공하고 공기배증을 유지하기 위해 사용됩니다.

금기사항

- Advincula Delineator는 자궁의 완전 적출 시에만사용합니다.
- 이 일회용 거상기는 IUD가 제자리에 있을 때, 환자가임신 중일 때, 또는 임신을 계획 중일 때 사용해서는 안됩니다.

경고

- Koh 질절개 컵은 외과용 전기 장치와의 사용을 위한Ultem® 플라스틱 및 초음파 절삭기와 레이저와의사용을 위한 스테인리스강의 두 가지 버전이 있습니다.이러한 컵은 교체할 수 없으며 검증되지 않은 다른에너지원과 사용해서는 안 됩니다.
- 잘못된 크기의 Koh 컵을 사용하면 환자 상해를 야기할 수 있습니다.
- 내용물은 멸균 상태로 제공됩니다.
- 멸균 장벽이 손상된 경우에는 사용하지 마십시오.
- 장치가 개봉되었거나 손상된 경우에는 사용하지마십시오.

- 자궁 말단 풍선을 10cc가 넘는 공기로 과다팽창시키지 마십시오.
- 질절개를 시작하기 전에 Koh-Efficient가 제자리에잡혀 있는지 항상 확인 하십시오.
- 일회용. 재사용, 재처리 또는 재멸균하지 마십시오. 재사용, 재처리 또는 재멸균은 장치의 구조적 무결성을저해하거나 장치 고장으로 이어져 환자 상해, 질병 또는사망으로 이어질 수 있습니다. 재사용, 재처리 또는재멸균 은 장치의 오염 위험을 야기하거나 또는 한환자에서 다른 환자로의 전염 병 전파 등을 포함한 환자감염 또는 교차 감염을 유발할 수도 있습니다. 장치오염은 환자의 상해, 질병 또는 사망으로 이어질 수있습니다.
- 해당되는 모든 연방, 주, 지역 의료/위험 폐기물관행에 따라 폐기하십시오.

주의

미 연방법에 따라 이 장치는 의사에 의해 또는 의사의주문에 따라 판매할 수 있습니다.

사용 지침

측심

1. 센티미터로 눈금이 매겨진 자궁 측심기구(비포함)를 사용해 자궁을 측 심하여 그 깊이를결정합니다(기저에 대한 외부 OS).

크기 결정

1. 센티미터로 눈금이 매겨진 자궁경부 크기 결정기구(비포함)를 사용해 자궁경부 직경을 측정하여사용할 Koh 컵의 적절한 크기(2.5cm, 3.0cm, 3.5cm 또는 4.0cm직경 컵)를 결정합니다.

확장

1. 당기개(비포함)를 사용하여 자궁경부순을 잡습니다.
2. 자궁경부 확장기(비포함)를 사용하여 자궁경부를 8Hegar/Hank(24프렌치)까지 확장하여 거상기 삽입을 용이하게 합니다.
3. 완료되면 적절한 Advincula Delineator 파우치를 개봉합니다.

풍선 테스트 팽창

1. 풍선 두 개를 모두 테스트 팽창합니다(공기량은 아래차트 참조).

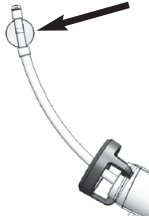
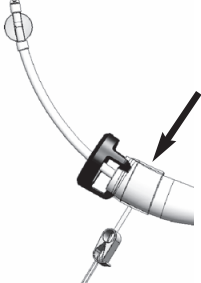
자궁 끝 풍선	폐 폐색 풍선
 <p>공기량: 10cc</p>	 <p>공기량: 40~60cc</p>

2. 팽창한 동안 두 풍선을 모두 육안 검사합니다.
3. 그런 다음 두 풍선을 모두 완전히 수축시킵니다.

삽입

1. 당기개(비포함)를 사용합니다.
2. 거상기 끝을 장치의 원위 측심 번호를 사용하여 미리정해진 측심 깊이 까지 천천히 삽입합니다.



삽입용 원위 번호

3. I자궁 끝 풍선을 최대 10cc 공기로, 또는 저항감을느낄 때까지 천천히 팽창시킵니다. 당기개를 제거합니다
4. 일련의 근위 번호를 사용하여 Koh-Efficient를 측심번호를 향해 밀고 위치 잠금장치에서 아래로 눌러제자리에 고정합니다. 완전히 맞물리면, 가독성 향상을위해 위치 잠금장치의 투명 렌즈가 측심 깊이 번호를확대해야 합니다.



Koh-Efficient 설정용 근위 번호

5. 완전히 삽입되면 자궁경부가 질절개 컵에 완전히안착되어 있는지 육안 또는 촉진으로 확인합니다.
6. 장치를 부드럽게 당겨 끝이 자궁에 적절히 맞물려있는지 테스트합니다.
7. 질절개 직전에 60cc의 공기로 폐 폐색 풍선을팽창시킵니다. 공기배중 손실이 발생할 경우, 추가로최대 60cc를 추가할 수 있습니다.













팁 이탈/완성

자궁에서 Advincula Delineator를 제거하기 전에 자궁 끝풍선 및 폐 폐색 풍선에서 모두 공기를 제거하십시오. 장치를 병원 지침에 따라 폐기하십시오.

보관

실온에서 보관하고, 극단적 온도를 피하십시오.

기호 설명

	재주문 번호		천연 고무 라텍스로 제조되지 않음
	로트 번호		재사용 금지
	사용기한		재멸균 금지
	에틸렌 옥사이드로 멸균		포장이 손상된 경우 사용 금지
	사용법 설명서 참조		제조업체
	주의		MDD(의료기기 인증) 93/42/EEC 준수
R_x Only	미 연방법에 따라 이 장치는 의사에 의해 또는 의사의 주문에 따라 판매할 수 있습니다.		유럽공동체 공인 대리인

Advincula Delineator™는 CooperSurgical, Inc.의 상표입니다.
 Koh-Efficient®는 CooperSurgical, Inc.의 등록 상표입니다.
 Koh Cup™은 CooperSurgical, Inc.의 상표입니다.
 Ultem®은 SABIC Global Technologies B.V.의 등록 상표입니다.
 CooperSurgical은 CooperSurgical, Inc.의 등록 상표입니다.

© 2016 CooperSurgical, Inc.



CooperSurgical, Inc.
95 Corporate Drive
Trumbull, CT 06611 USA

95 Corporate Drive
Trumbull, CT 06611 USA
Phone: (800) 243-2974
Fax: (800) 262-0105

International
Phone: (203) 601-9818
Fax: (203) 601-4747



EMERGO EUROPE
Molenstraat 15
2513 BH, The Hague
The Netherlands

www.coopersurgical.com

38501-IFU • Rev. A • 7/16

Made in the USA